

# Product Selection Catalogue

humidification systems

# CAREL

Product Selection Catalogue humidification systems

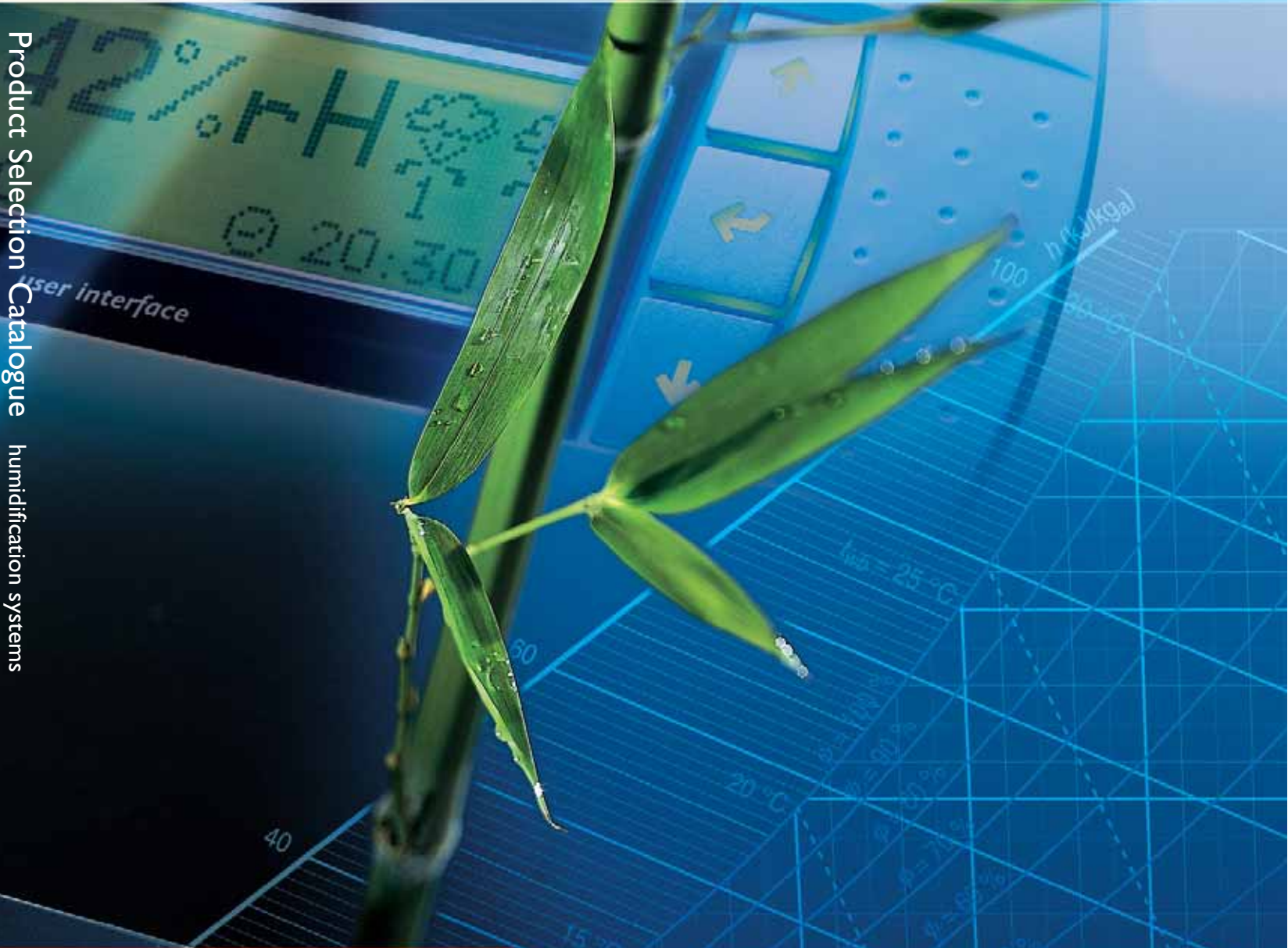

humidification for life

CAREL



# Product Selection Catalogue

humidification systems

# CAREL



humidification for life





## References

Many people have chosen our humidification solutions, people who came to us with trust and knowledge.

These people, our customers, not only include large and well-known companies, but also lesser-known entities, who for us are equally important. We would like to mention them all, but there are too many. Suffice to say that these people have allowed us to see our humidity control solutions

installed in major museums, where they help protect works of art that are part of our heritage, in facilities that manufacture mobile phones and computers, where highly sophisticated tests are performed in a humidity-controlled environment, in many banks and even more hospitals all over the world, places where air quality is crucial for those who work there and above all those who need to get better.



ABB - Amsterdam (The Netherlands), AEROSPATIALE - Nantes (France), AIRPORT CASELLE - Turin (Italy), AIRPORT LINATE - Milan (Italy), AIRPORT "G. MARCONI" - Bologna (Italy), ANALOG DEVICES - San José (CA - USA), APRILIA - Noale (Italy), BARILLA - Parma (Italy), BEIJING MEDICAL UNIVERSITY OPHTHALMOLOGY CENTER - Beijing (China), BILL GATES' HOUSE - Seattle (USA), BMW ITALY - S. Donato Milanese (Italy), BOEING AIRCRAFT - Seattle (USA),

BORDEAUX AIRPORT - Bordeaux (France), BUGATTI - Bologna (Italy), CAMERA DEI DEPUTATI - Rome (Italy), CEGELEC - Paris (France), CNR - Padua (Italy), COSTA CROCIERE (Italy), EREMITANI MUSEUM - Padua (Italy), FERRARI - Maranello (Italy), FLEMISH PARLIAMENT - (Belgium), FRANCE METEO - Toulouse (France), HEIDENBERG INDUSTRY - Heidenberg (Germany), HEWLETT-PACKARD - San José (USA), IBM E.D.P. - Amsterdam (The Netherlands), "IL

Wine and food producers, especially in Mediterranean countries, use our humidifiers to ensure the total quality of their produce. Our solutions can also be found at the leading automobile manufacturers, both makers of the cars we use every day and Formula 1 racing cars. From the earth to the skies: CAREL humidification solutions have been installed by the major builders of today's and tomorrow's aircraft.

Behind all these companies are people who have chosen our products, men and women who we have got to know personally and through our agents.

We would like to thank them all, with the commitment and the promise to do even more, so that their satisfaction lasts even longer.



SOLE 24 ORE” - Milan (Italy), INTEL - San José (USA), JAGUAR - (UK), KODAK NUMERAL CAMERA - Xiamen and Shanghai (China), LA CORUÑA HOSPITAL “JUAN CARDONA” - La Coruña (Spain), LOUVRE MUSEUM - Paris (France), MOTOROLA - Phoenix (USA), MINISTRY OF AGRICULTURE - Hiroshima (Japan), MINISTRY OF FINANCE - Lisbon (Portugal), MINSTER COURT - London (U.K.), NEW YORK TIMES - New York City (USA),

PHILIPS ELECTRIC COMPONENT - Shanghai (China), PLANT GARDEN - Taipei (Taiwan), SGS THOMPSON - Paris (France), TABACALERA - Terragona (Spain), TIANJING TIANCAI OPTICAL FIBRE BASE - Tianjing (China), TSIMIS PRINTING - (Greece), UNIVERSAL AVIONICS - Phoenix (USA), WASHINGTON POST - Washington (USA), ZANUSSI - Pordenone (Italy)





## What is humidity?

Humidity is simply the presence of water vapour in the air.

Relative humidity, on the other hand, is the quantity of moisture present in the air at a certain temperature as a proportion of the maximum quantity of water vapour that the air can hold at that temperature when it is saturated.

*At 21 °C, 1 kg of dry air can hold up 15.8 g of moisture and it is said to be at 100% of relative Humidity (rH).*

The quantity of moisture that the air can hold changes as the temperature changes, and increases when the air temperature increases. Consequently, while 1 kg of dry air at 21 °C can hold up to 15.8 g of water vapour, the same quantity of air at -18 °C can only hold around 0.92 grams.

*If you have 1 kg of dry air at 21 °C with 50% rH (that is about 7.9 g), as you cool this air, it will reach saturation (100% rH) at 9.5 °C. Conversely, if you take 1 kg of dry air at -18 °C and 100% rH (that is about 0.92 g) and raise its temperature to 21 °C without adding any more moisture, you will end up with 6% rH ( $0.92/15.8 = 0.06$ ).*

## Why is dry air a problem?

When the outside temperature falls below the inside temperature, the cold and moist air that enters a heated building becomes hot and dry.

This happens due to a phenomenon by which equilibrium is established between the moisture in the objects inside the building and in the air that these are in contact with.

The reduction in the moisture in the air may cause well known problems, such as:

- dryness of the upper airways
- cracks in wooden structures
- electrostatic discharges.

Air-conditioning or refrigeration systems may also cause an increase in the dryness of the air, as they cool the air below its dew point, remove moisture (dehumidification) and subsequently reheat the air.

**dew point:** this is the temperature that air must reach (while maintaining a constant pressure and humidity) for the moisture to condense (saturation).

**dehumidification:** process by which the moisture in the air can be decreased or removed



## Isothermal and adiabatic humidification

There are two different procedures that can be applied to increase the degree of moisture in the air:

- isothermal humidification;
- adiabatic humidification.

In the isothermal humidification process, the water vapour is dispersed in the environment after having been created by boiling water.

This procedure requires the contribution of an external source of energy to change the state of the water.

As the temperature of the water vapour is higher than that of the air, the temperature of the air tends to increase.

The adiabatic process does not involve the contribution of thermal energy from an external source: the water is finely atomised and introduced into the environment. The heat required to transform the water from liquid to vapour is supplied by the air, which is consequently cooled.

## Why humidification?

The need to humidify an environment is determined by a number of factors:

1. the presence of hygroscopic material (capable of absorbing moisture from the air);
2. the presence of static electricity;
3. the importance of well-being and comfort.

### 1. Hygroscopic materials

If a piece of wood in equilibrium with the moisture content in the outside air is brought into a heated room with a lower humidity, the wood will start to release part of its moisture to the dry air in the room. As the wood releases its moisture, it will contract, leading to the formation of cracks or deformations. The same damage can be seen in paper, fabrics, some plastics materials, wax, fruit and vegetables and other materials that have the property to absorb or release moisture.

Hygroscopic is the term given to materials whose cells absorb moisture, leading to a variation in their dimensions. This is different from hydrophilic absorption, in which case the water is absorbed into the cells of the material with NO consequent variation in dimensions.

Hygroscopic materials tend to reach equilibrium with the surrounding environment. It is therefore the variation in the dimensions of the materials, due to the change in relative humidity, that affects the workability of the materials and the production



processes even more significantly than the temperature. The protection of hygroscopic material can be guaranteed only by the stability of the environment they are situated in. This objective can be achieved by dehumidification when the air becomes too moist, and humidification when the air is too dry.

### **Printing**

Paper reaches the printing facilities in the form of reels, conditioned in the paper mill with a certain quantity of moisture and packaged in impermeable material to ensure that such moisture is maintained. As soon as the packaging is removed, if the air in the environment is drier, the paper starts to lose moisture and its cells contract. A reel of paper may vary in size by a number of centimetres, in both width and length. When the reel of paper is placed in the printing press and unwound, it quickly loses moisture. These variations, which may also occur in a very short period, can cause problems, mainly when printing with a number of different colours. One of the solutions is to adjust the rollers to compensate for this error, however if the humidity varies too quickly, frequent adjustments are required, with consequent loss of paper and time and reduction in production speed.

The stabilisation of the ambient conditions, thanks to appropriate humidity control, ensures that the dimensions of the paper remain constant and that the printing process will be faster, limiting downtime during production.

### **Woodworking**

During the humidification or dehumidification process, wood expands or contracts, causing cracks, breakages, shrinkages and deformations. When drying, wood absorbs the solvent of the finishes, taking on a granular and matt appearance. Similarly, the glued joints are unstable, as the wood absorbs the solvent of the glue before the glue has the chance to polymerise. In this case too, the stabilisation of the environmental conditions allows the wood to maintain the same dimensions throughout the entire process, ensuring better results.

### **Textile industry**

If the textile fibres are dry when they are run through the looms, they become fragile and break, leading to stoppages and a slowing down of production.

In addition, the fibres that break release fluff into the air, often causing a worsening of the air quality. Appropriate humidification reduces the breakage of the fibres, the quantity of dust in the air and at the same time speeds up the operation of the looms.

### **Offices**

Dry air in the winter increases the level of dust present in the air. With correct humidification, the quality of the air can be improved, reducing the concentration of dust due to a decreased fragmentation of fibres, as well as the increased tendency of particles to agglomerate and therefore be more effectively filtered.

### **Hi-tech microchip manufacturing**

Chips are becoming increasingly smaller, and the distances are now measured in Angstroms. For this reason, even a slight variation in the dimensions of a silicon wafer during the photographic masking process causes unacceptable misalignments and the consequent malfunction of the components.

### **Museums**

The correct stabilisation of the environment is essential for preserving works of art over time. If canvases were to constantly change dimensions, paintings could be irreversibly damaged; in addition works made from wood or on parchment could start to deteriorate in a short time if the surrounding environment was too dry.

### **Defence**

At Boeing, McDonnell Douglas, Hughes Aircraft and Lockheed, humidity control is considered of the maximum importance for the new stealth technology. The paint used is very sensitive to ambient humidity and if it polymerises incorrectly due to an environment that is too dry it will crumble, leaving metal exposed to the reflection of radar waves.

### **Food processing**

Meats maintain their red colour without the addition of nitrates if they are preserved in suitable containers and appropriately humidified cold stores. If fruit or vegetables lose too much moisture, the cells of the vegetables dry out irreversibly. For this reason it is important for the foodstuffs to be humidified from the moment they reach the store to when they are purchased by the consumer.

## **2. Static electricity**

Static electricity is reduced significantly when the relative humidity is maintained above 35%. There are many sectors of industry that are especially sensitive to this problem.

### Computer rooms

The poor control of the humidity in a computer room involves the potential accumulation of static electricity, which when discharged may damage electronic components. If the air is too dry, for example, the high speed printers may generate electrostatic charges when driving the paper.

### Printing

In the printing process, as well as the hygroscopic variations in paper, the problem of electrostatic discharges may also arise. The solvents contained in the printing presses may catch fire if the electrostatic discharges ignites the vapour. In addition, the printing presses may generate electrostatic charges when driving the paper (a newspaper press may generate up to 2,000,000 volts when driving the paper).

### Photography

Most photographic laboratories feature humidity control systems to prevent the accumulation of charges on the films. This phenomenon is of special significance in relation to X-ray films in hospitals.

## 3. Well-being and comfort

In today's complex society, well-being and comfort have assumed crucial importance. Correct humidification, as well as a reduction in the amount of dust in suspension, ensures that the people present in closed rooms can breathe correctly, without problems deriving from the dryness of the upper airways. In addition, the reduction of cutaneous evaporation resulting from correct humidification reduces the feeling of cold and consequently allows the temperature of the room to be kept lower, saving on heating bills and limiting the dispersion of heat between the inside and the outside of the building.

APPLICATIONS	ISOTHERMAL					ADIABATIC		
	humiSteam UE	homeSteam UM	heaterSteam UR	gaSteam UG	ultimateSteam DS	humiFog UA	mc system MC	humiDisk HDU
<b>Pure environments</b>								
sterile/aseptic environments	●	●	●	●	3			
clean environments	●	●	●	●	3	1	1	
hospitals/laboratories	●	●	●	●	3	1	1	
<b>Civil environments</b>								
houses	●	●	●	●				
steam baths	●		●	●				
offices	●	●	●	●	3	2	2	
libraries	●	●	●	●	3	2/3	2/3	
museums	●	●	●	●	3	2/3	2/3	
fan coils	●	●	●	●				
<b>Food industry</b>								
production lines					3	4	4	
cold rooms						●	●	●
ripening rooms						●	●	●
bread leavening	●	●	●	●	3			
cheese maturing	●	●	●	●	3			
display cabinets								
wine cellars and wine barrels	●		●	●	3	●	●	●
<b>Other industrial applications</b>								
wood storage	●		●	●	3	●	●	
paper mills						●	●	
printing facilities	●		●	●	3	2	●	
photographic labs	●		●	●	3	2	2	
textiles						●	●	
tobacco ripening and storage	●	●	●	●	3	●	●	●
cigars storage	●	●	●	●	3	●	●	●
amusement parks						●	●	
<b>Farming applications</b>								
animal breeding						●	●	
hatching						●	●	
greenhouses						●	●	●

1. Humidify in duct, use demineralized water only and do regular maintenance according to ASHRAE 12-2000 and VDI6022
2. Atomise water inside a duct only
3. Steam/water containing treatment chemicals should not be used
4. Demineralized water is recommended





***Isothermal humidifiers*** pag. 13

---

*Immersed electrode humidifiers* pag. 13

*Heater humidifiers* pag. 24

*Gas humidifiers* pag. 34

*Centralised steam distributors* pag. 40

*Accessories* pag. 44

***Adiabatic humidifiers*** pag. 47

---

*Pressurised water atomisers* pag. 48

*Compressed air and water atomisers* pag. 56

*Centrifugal humidifiers* pag. 62

***Control devices*** pag. 67

---

*Probes* pag. 68

*Controllers* pag. 72





# **Isothermal humidifiers**

---





## Immersed electrode humidifiers

The operation of the immersed electrode humidifier is based on a very simple physical principle. As common drinking water contains a certain quantity of dissolved mineral salts, and is consequently slightly conductive, applying a voltage to metal electrodes immersed in the water creates an electric current that heats the water until producing steam (Joule effect). This electric current – proportional at any instant to the amount of steam produced – is measured by a current transformer. By varying the level of water (and therefore the immersed portion of the electrodes) using a fill and drain electrovalve, the steam production can be precisely modulated. Due to evaporation, the level of water decreases and must therefore be topped up; as the steam does not carry the mineral salts, the salt concentration in the water and therefore the conductivity increases, meaning that the water has to be periodically diluted by draining part of it and replacing it with new water. In addition, lime scale is deposited over time

and covers part of the cylinder, which must be replaced or cleaned.

The principle is simple, however the development of an immersed electrode humidifier that ensures safe operation and reliability over time requires careful analysis and extended testing.

Compared to the complementary immersed element heater or gas humidifiers, immersed electrode humidifiers:

- are less expensive to purchase;
- operate with drinking water (not completely demineralised or softened);
- require the periodical replacement (or cleaning) of the cylinder;
- feature modulation suitable for comfort or industrial applications, without extreme requirements.

CAREL has been manufacturing immersed electrode humidifiers since the 1970s and can draw benefit from its know-how in the field of electronic controllers: precision control, reliable electronics and sophisticated and complete control software.

CAREL solutions for the immersed electrode humidifiers are **humiSteam** and **homeSteam**.



Interface for the P control



Interface for the H control



## Controllers

The **humiSteam** series humidifiers are available with two different types of control unit, with the following codes:

- type "P": humidifiers managed by a signal generated by an external controller;
- type "H": humidifiers with built-in control unit, for stand alone applications.

Both models are fitted with a remote enabling input and alarm relay.

### • Type P control: ON/OFF or Proportional

In the **humiSteam** humidifiers with type "P" control, the production of humidity is managed by an input signal, generated from an external system.

Depending on the type of signal available, the humidifier can operate in one of the following modes:

- **ON/OFF mode:** a simple contact (such as a humidistat) enables or disables the production of steam.
- **proportional mode:** the humidifier produces a quantity of steam that is directly proportional to the signal (0 to 10 V) generated by the external controller. The minimum production is set at 20% of rated capacity, and consequently steam production can be precisely modulated between 20% and 100% of maximum capacity.

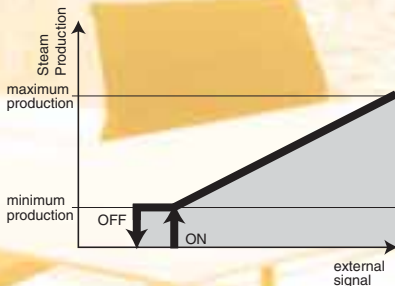

The type "P" humidifiers are fitted with a simple icon-based interface that shows, instant by instant, the normal operating conditions and any diagnostic indications.

*Configuration: the humidifiers with type "P" control must be connected to a humidistat, or an external control system; they are not designed for closed loop internal control.*

### • Type H control: modulating, with built-in controller

The type "H" units are fitted with a built-in controller, which

must be connected to a humidity probe in the environment for closed loop control. All type "H" **humiSteam** models feature an interface for operation management and programming, based on a display with alphanumeric codes, icons and 4 buttons. The steam production decreases the closer the humidity level, measured by the probe, gets to the set point. It is modulated continuously between 20% and 100% of maximum capacity, allowing precise humidity control.

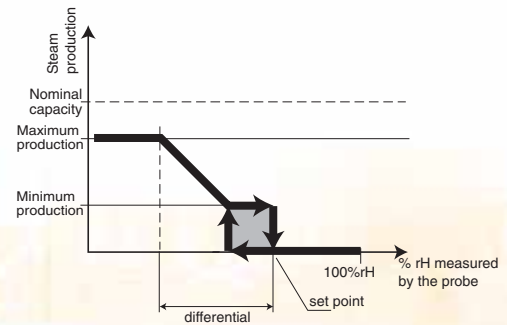

With type "H" control, the operating mode and the configuration of the humidifier can be easily set depending on the application, using the interface. For example, in the event of ducted installations, the type "H" control allows the connection of two humidity probes – one in the environment and one at the outlet, to be installed in the duct. The same unit can also control a dehumidifier, using an output signal. For steam bath applications, control can be implemented by a the signal from an active temperature probe. Units with type "H" control can also be configured to operate with type "P" control. The **humiSteam** humidifiers are compatible with all the more commonly-used types of probes and controllers available on the market: 0 to 1 Vdc, 0 to 10Vdc, 2 to 10 Vdc, 0 to 20 mA and 4 to 20 mA. Up to 4 different humidifiers can be connected to a humivisor (see chapter accessories page 42), at a maximum distance of 1 km, for centralised control of the operation and operating parameters of each unit. The parameters can also be programmed using a special infrared remote control.

*Configuration: the type "H" humidifiers feature of a built-in humidity control system, which must be connected to an external humidity probe.*





## humiSteam range

The vast range of humiSteam immersed electrode humidifiers include units producing from 1.5 to 130 kg/h of steam.

Compared to the previous SD2000 range, completely replaced by humiSteam offers significant advantages both in terms of performance, with a wider range of modulation and a more efficient antifoam system, and economics, with larger and longer lasting cylinders and an excellent quality/price ratio. humiSteam works on mains water with a conductivity between 125 and 1250  $\mu\text{s}/\text{cm}$ , and its control software automatically adjusts operation according to the characteristics of the water, so as to optimise the period of operation without maintenance.

The new 65 kg/h (single cylinder) and 90 and 130 kg/h (twin cylinder) models that complete the humiSteam range, feature new cylinders with a longer operating life and more compact outside dimensions than

competing models.

The twin cylinder models, furthermore, are fitted with the new “pHC” control, which has the same functions as the “H” control, plus an alphanumeric and graphic display with extended and easy-to-understand signals and messages.



Another new release is the 9 kg/h model with single-phase power supply, ideal for use as a steam generator for steam baths, where three-phase power supply is often not available.

humiSteam is suitable for installation directly into the room, with a ventilated steam distributor, and for ducted installation, with the new range of linear steam distributors. humiSteam is suitable for the use in civil environments, offices, hospitals, industrial establishments, and in steam baths.

**For humiSteam accessories refer to page 42.**



## Advantages

- **“Anti Foaming System”**: prevents the release of droplets together with the steam;
- **large cylinders with galvanised electrodes and anti-scale filter** in the base, for longer maintenance free operation. Openable and fireproof cylinders are also available;
- **steam production with continuous modulation** from 20% to the max. flow-rate;
- **built-in conductivity sensor and control software** to optimise energy efficiency and operating life, with constant performance over the life of the cylinder;
- **choice between two types of control**: **“H”** (modulating with external humidity probe) and **“P”** (proportional or ON/OFF from external controller);
- **model “H”** manages a second “limit” probe to prevent any condensate forming in the air duct, and supports all operating modes: ON/OFF, proportional, with relative humidity probe, and with temperature control for use as a steam generator in steam baths.

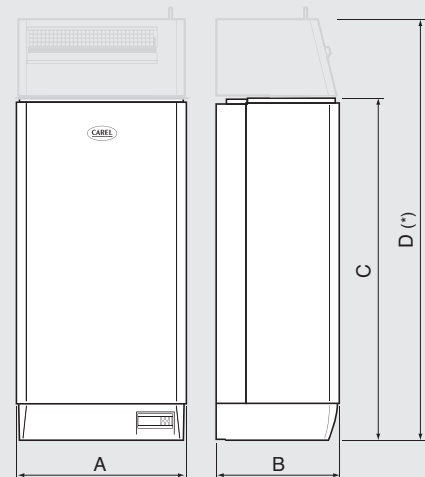

(\*) Height with top mounted ventilated steam distributor

	Humidifier dimensions				Packaging			
	A	B	C	D	A1	B1	C1	Weight
<b>Models</b> UE 1/8 kg/h	365	275	620	766	520	380	730	16
UE 9/15 kg/h	365	275	710	901	520	410	870	20
UE 25/45 kg/h	555	360	890	-	680	460	1090	39
UE 65 kg/h	650	455	945	-	820	520	1070	51
UE 90/130 kg/h	1150	465	890	-	1210	505	1020	81



## homeSteam

homeSteam is an immersed electrode steam humidifier available in 1.5 kg/h and 3.2 kg/h models.

homeSteam combines the most advanced CAREL technology with simplicity of use, guaranteeing reliability and versatility as well as ease of installation and maintenance. This compact steam humidifier has been designed for the humidification of residential environments of up to 500 square metres, and is controlled by an external humidistat.

homeSteam is fitted with a simple and easily understandable control interface, (which requires minimum supervision). The maintenance operations, such as the replacement and the cleaning of the boiler, are elementary; the boiler can be cleaned using a normal household descaler. homeSteam works with mains water with conductivity between 125 and 1250  $\mu\text{S/cm}$ .

**For humiSteam accessories refer to page 42.**

### Advantages

- **professional construction:** directly derived from the humiSteam, it uses the same cylinders and plumbing components, for long life and tested reliability;
- **“Anti Foaming System”:** prevents the release of droplets with the steam;
- **three LED display:** indicates when the unit is on, when the humidifier is producing steam, and if there are any alarms.

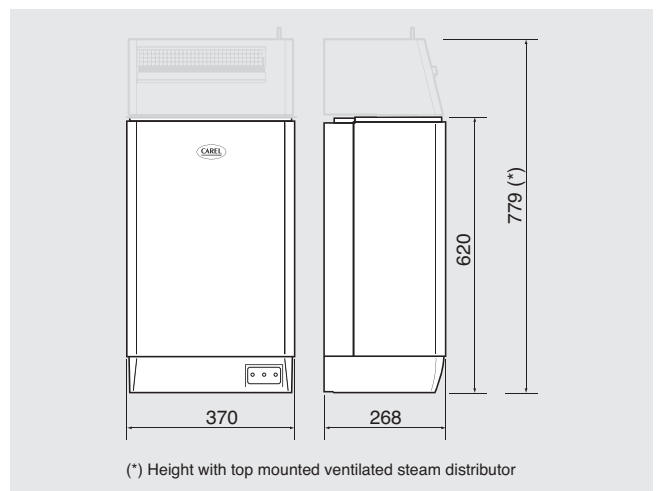

# OVERVIEW DRAWING

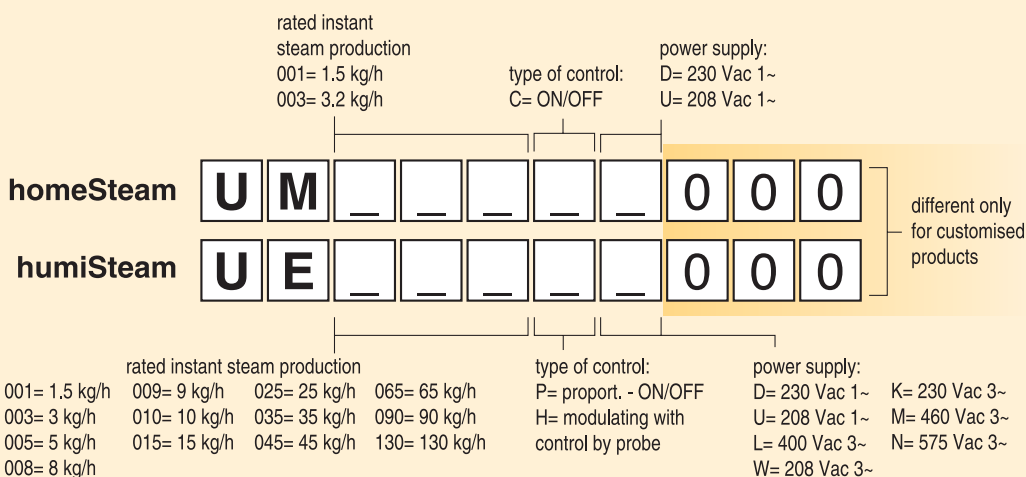
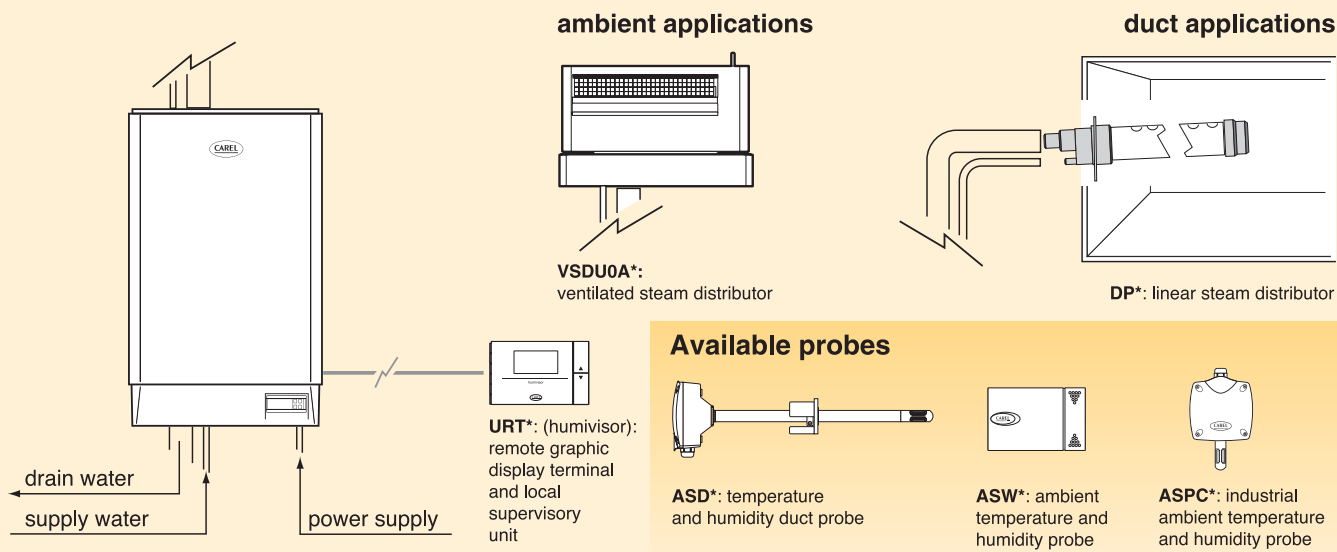

**Note:** that not all combinations of characters are available. Please contact CAREL dealer for further information.

## Table of humiSteam and homeSteam control

Control	UEH	UEP	UMC	HPC
Inputs	0 to 1 Vdc; 0 to 10 Vdc; 2 to 10 Vdc; 0 to 20 mA; 4 to 20 mA	0 to 10 Vdc	contact ON/OFF	0 to 1 Vdc; 0 to 10 Vdc; 2 to 10 Vdc; 0 to 20 mA; 4 to 20 mA
Input impedance	60 kΩ with 0 to 1 Vdc signals; 0 to 10 Vdc; 2 to 10Vdc 50 Ω with 0 to 20 mA and 4 to 20 mA signals	15 kΩ	-	60 kΩ with 0 to 1 Vdc signals; 0 to 10 Vdc; 2 to 10Vdc 50 Ω with 0 to 20 mA and 4 to 20 mA signals
Alarm relay	250 Vac, 8 (2) A	250 Vac, 5 (2) A	250 Vac, 5 (2) A	250 Vac, 8 (2) A
Communication	RS485; Modbus® opt.; BACnet™ opt.	-	-	RS485; Modbus® opt.; BACnet™ opt.
Power to active probes	24 Vdc (24 Vac rectified) Imax 250 mA; 12 Vdc Imax 50 mA	-	-	24 Vdc (24 Vac rectified) Imax 250 mA; 12 Vdc Imax 50 mA
Remote enabling input	Volt free contact; max resistance 50 Ω; Vmax 24 Vdc; Imax 5 mA			



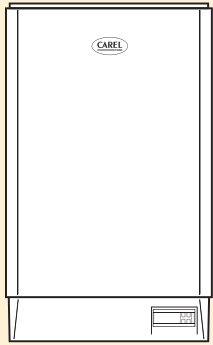
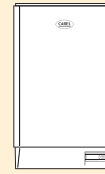

Modello	UE001*	UE003*	UE005*	UE008*	UE009*
Rated steam production	1.5 kg/h	3 kg/h	5 kg/h	8 kg/h	9 kg/h
Power input	1.12 kW	2.25 kW	3.75 kW	6.00 kW	6.75 kW
Power supply					
– 200, 208 or 230 Vac (-15% to +10%), 50/60 Hz, single-phase	●	●	●		●
– 200, 208, 230, 400, 460, 575 Vac (-15% to +10%), 50/60 Hz, three-phase (*)		●	●	●	
Fitting	Ø 22/30	Ø 22/30	Ø 30	Ø 30	Ø 30
Steam pressure	0 to 2000 Pa	0 to 2000 Pa	0 to 1600 Pa	0 to 1600 Pa	0 to 1700 Pa
Number of boilers	1	1	1	1	1

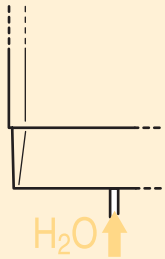

Fitting	3/4"G male				
Temperature limits	1T40 °C				
Water pressure limits	0.1 to 0.8 MPa - 1 to 8 bar				
Instant flow-rate	0.6 l/min	0.6 l/min	0.6 l/min	0.6 l/min	1.2 l/min
Total hardness	15 to 40 °fH				
Conductivity limits	125 to 1250 µS/cm				

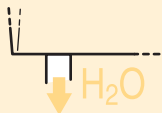

Fitting	Ø 40				
Temperature	<100 °C				
Instant flow-rate	5 l/min	5 l/min	5 l/min	5 l/min	5 l/min

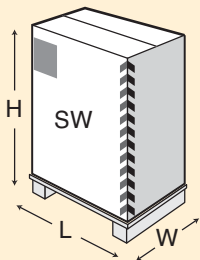

Humidifier (LxWxH)	365x275x620	365x275x620	365x275x620	365x275x620	365x275x710
Weight (empty)	13.5 kg	13.5 kg	13.5 kg	13.5 kg	17 kg
Packaging (LxWxH)	520x380x730	520x380x730	520x380x730	520x380x730	520x410x870
Weight of packaged humidifier (SW)	16 kg	16 kg	16 kg	16 kg	20 kg
Operating conditions	1T40 °C, 10 to 90% rH non-cond.				
Storage conditions	-10T70 °C, 5 to 95% rH non-cond.				
Index of protection	IP20				

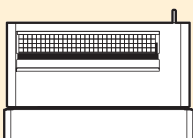

Ventilated distributor VSDU0A	●	●	●	●	●
Power supply / rated power	230 Vac / 30 W	230 Vac / 30 W	230 Vac / 30 W	230 Vac / 30 W	230 Vac / 30 W
Rated air flow	170 m³/h	170 m³/h	170 m³/h	170 m³/h	170 m³/h

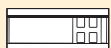

Control	UEH*/UEP*				
---------	-----------	--	--	--	--



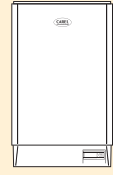
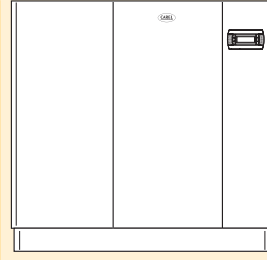
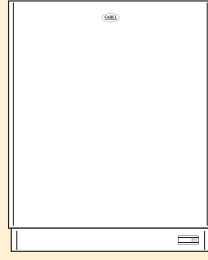
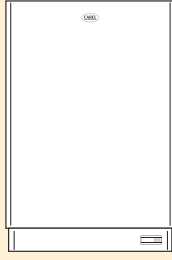

UE010*	UE015*	UE025*	UE035*	UE045*	UE065*	UE090*	UE130*	UM001*	UM003*
10 kg/h	15 kg/h	25 kg/h	35 kg/h	45 kg/h	65 kg/h	90 kg/h	130 kg/h	1.5 kg/h	3.2 kg/h
7.50 kW	11.25 kW	18.75 kW	26.25 kW	33.75 kW	48.75 kW	67.5 kW	97.5 kW	1.12 kW	2.40 kW
•	•	•	•	•	400, 460, 575 Vac (-15% to +10%), 50/60 Hz, three-phase			•	•
Ø 30	Ø 30	Ø 40	Ø 40	Ø 40	Ø 2x40	Ø 2x40	Ø 4x40	Ø 22/30	
0 to 1700 Pa	0 to 1700 Pa	0 to 2300 Pa	0 to 2300 Pa	0 to 2300 Pa	0 to 2300 Pa	0...2300 Pa	0...2300 Pa	0 to 2000 Pa	
1	1	1	1	1	1	2	2	1	
3/4"G male								3/4"G male	
1T40 °C								1T40 °C	
0.1 to 0.8 MPa - 1 to 8 bar								0.1 to 0.8 MPa - 1 to 8 bar	
1.2 l/min	1.2 l/min	4 l/min	4 l/min	4 l/min	7 l/min	2 x 7 l/min	2 x 7 l/min	0.6 l/min	
15 to 40 °FH								15 to 40 °FH	
125 to 1250 µS/cm								125 to 1250 µS/cm	
Ø 40								Ø 40	
<100 °C								<100 °C	
5 l/min	5 l/min	22.5 l/min	22.5 l/min	22.5 l/min	22.5 l/min	45 l/min	45 l/min	5 l/min	
365x275x710	365x275x710	555x360x890	555x360x890	555x360x890	650x455x945	1150x465x890	1150x465x890	360x268x620	
17 kg	17 kg	34 kg	34 kg	34 kg	44 kg	74 kg	74 kg	13.5 kg	
520x410x870	520x410x870	680x460x1090	680x460x1090	680x460x1090	820x520x1070	1210x505x1020	1210x505x1020	520x380x740	
20 kg	20 kg	39 kg	39 kg	39 kg	51 kg	81 kg	81 kg	16 kg	
1T40 °C, 10 to 90% rH non-cond.								1T40 °C, 10 to 90% rH non-cond.	
-10T70 °C, 5 to 95% rH non-cond.								-10T70 °C, 5 to 95% rH non-cond.	
IP20								IP20	
•	•	-	-	-	-	-	-	•	
230 Vac / 30 W	230 Vac / 30 W	-	-	-	-	-	-	230 Vac / 30 W	
170 m³/h	170 m³/h	-	-	-	-	-	-	170 m³/h	
UEH*/UEP*								UMC*	

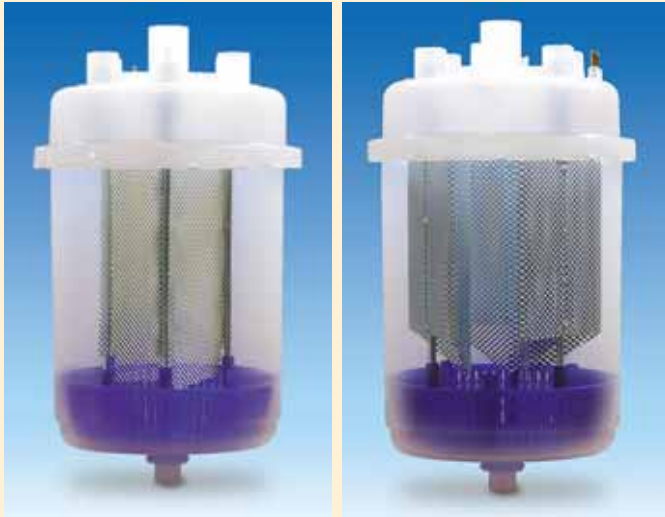

### The range of humiSteam cylinders

All the CAREL immersed electrode humidifiers feature sophisticated control software that automatically adapts the operating parameters to the characteristics of the water; nonetheless, the optimum balance between duration, variation of steam production and speed of response depending on the type of water and the power supply can only be achieved by changing the shape and the position of the electrodes.

For this reason, the CAREL immersed electrode humidifiers today feature the widest choice of cylinders, with specific electrodes for water with conductivity between 125 µS/cm and 1250 µS/cm, for capacities between 1 and 65 kg/h, and for power supply voltages between 200 V and 575 V.

This extraordinary range of cylinders is the result of years of research and tens of thousands of hours of tests in the CAREL Humidification Laboratory under the widest possible range of uses. This ensures the right solution in every circumstance.

All the humiSteam cylinders feature large galvanised electrodes, positioned inside the cylinder so as to optimise duration and constant performance over the working life of the cylinder. In addition, significant attention has been paid to operation on water with more critical characteristics, to reduce the phenomenon of arcing. All cylinders are also fitted with filters to avoid the formation of lime scale in the base, preventing the blockage of the drain.

#### Openable cylinders

The new humidifiers can be fitted with “disposable” cylinders made from flame-retardant plastic, class HB according to UL94, or alternatively openable and therefore cleanable cylinders, made from class V0 flame-retardant plastic (UL94 standard). The openable cylinders feature quick click-on closing, with a rubber gasket to ensure perfect water-tight seal between the two parts of the cylinder.



### single-phase

	Voltage		Water conductivity (µS/cm)		
	230 Vac	200 Vac		1/3 kg/h	3 kg/h
disposable	350	350	1250	BL0S1F00H1	-
	1250	1250	1250	-	-
openable	125	125	350	BL0S1E00H1	-
	350	350	350	-	-
disposable	350	350	1250	BL0S1F00H1	-
	1250	1250	1250	-	-
openable	125	125	350	BL0S1E00H1	-
	350	350	350	-	-
disposable	350	350	1250	BL0S1F00H1	-
	1250	1250	1250	-	-
openable	125	125	350	BL0S1E00H1	-
	350	350	350	-	-

### three-phase

	Voltage		Water conductivity (µS/cm)		
	400 Vac	200 Vac		1/3 kg/h	3 kg/h
disposable	750	350	1250	-	BL0T1D00H1
	1250	1250	1250	-	-
openable	350	350	750	-	BL0T1C00H1
	1250	1250	1250	-	-
disposable	125	125	350	-	BL0T1A00H1
	350	350	350	-	-
openable	350	350	1250	-	BL0T1B00H1
	1250	1250	1250	-	-
disposable	125	125	350	-	BL0T1A00H1
	350	350	350	-	-
openable	350	350	1250	-	BL0T1B00H1
	1250	1250	1250	-	-
disposable	125	125	350	-	BL0T1A00H1
	350	350	350	-	-
openable	350	350	1250	-	BL0T1B00H1
	1250	1250	1250	-	-
disposable	125	125	350	-	BL0T1A00H1
	350	350	350	-	-
openable	350	350	1250	-	BL0T1D00H1
	1250	1250	1250	-	-
disposable	125	125	350	-	BL0T1C00H1
	350	350	350	-	-
openable	350	350	1250	-	BL0T1D00H1
	1250	1250	1250	-	-
disposable	125	125	350	-	BL0T1C00H1
	350	350	350	-	-
openable	350	350	1250	-	BL0T1D00H1
	1250	1250	1250	-	-

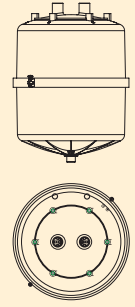
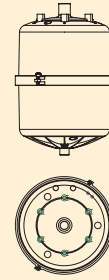
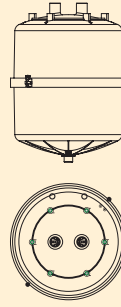
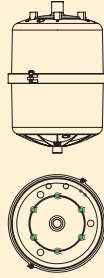
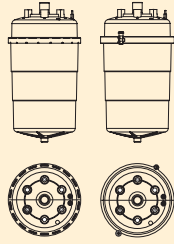
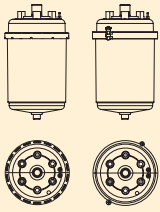

5 kg/h	5/8 kg/h	9 kg/h	10/15 kg/h	25/35 kg/h	45 kg/h	65 kg/h	90 kg/h	130 kg/h
<b>BL0S2F00H0</b>	-	<b>BL0S3F00H0</b>	-	-	-	-	-	-
BLCS2F00W0	-	BLCS3F00W0	-	-	-	-	-	-
BL0S2E00H0	-	BL0S3E00H0	-	-	-	-	-	-
BLCS2E00W0	-	BLCS3E00W0	-	-	-	-	-	-
<b>BL0S2F00H0</b>	-	<b>BL0S3F00H0</b>	-	-	-	-	-	-
BLCS2F00W0	-	BLCS3F00W0	-	-	-	-	-	-
BL0S2E00H0	-	BL0S3E00H0	-	-	-	-	-	-
BLCS2E00W0	-	BLCS3E00W0	-	-	-	-	-	-
<b>BL0S2F00H0</b>	-	<b>BL0S3F00H0</b>	-	-	-	-	-	-
BLCS2F00W0	-	BLCS3F00W0	-	-	-	-	-	-
BL0S2E00H0	-	BL0S3E00H0	-	-	-	-	-	-
BLCS2E00W0	-	BLCS3E00W0	-	-	-	-	-	-
-	BL0T2D00H0	-	BL0T3D00H0	BL0T4D00H0	BL0T4C00H0	BL0T5C00H0	2 x BL0T4C00H0	2x BL0T5C00H0
-	BLCT2D00W0	-	BLCT3D00W0	BLCT4D00W0	BLCT4C00W0	BLCT5C00W0	2 x BLCT4C00W0	2x BLCT5C00W0
-	<b>BL0T2C00H0</b>	-	<b>BL0T3C00H0</b>	<b>BL0T4D00H0</b>	<b>BL0T4C00H0</b>	<b>BL0T5C00H0</b>	<b>2 x BL0T4C00H0</b>	<b>2x BL0T5C00H0</b>
-	BLCT2C00W0	-	BLCT3C00W0	BLCT4D00W0	BLCT4C00W0	BLCT5C00W0	2 x BLCT4C00W0	2x BLCT5C00W0
-	BL0T2B00H0	-	BL0T3B00H0	BL0T4C00H0	BL0T4B00H0	BL0T5B00H0	2 x BL0T4B00H0	2x BL0T5B00H0
-	BLCT2B00W0	-	BLCT3B00W0	BLCT4C00W0	BLCT4B00W0	BLCT5B00W0	2 x BLCT4B00W0	2x BLCT5B00W0
-	<b>BL0T2B00H0</b>	-	<b>BL0T3B00H0</b>	<b>BL0T4C00H0</b>	<b>BL0T5B00H0</b>	-	-	-
-	BLCT2B00W0	-	BLCT3B00W0	BLCT4C00W0	BLCT5B00W0	-	-	-
-	BL0T2A00H0	-	BL0T3A00H0	BL0T4B00H0	BL0T5B00H0	-	-	-
-	BLCT2A00W0	-	BLCT3A00W0	BLCT4B00W0	BLCT5B00W0	-	-	-
-	BL0T2B00H0	-	<b>BL0T3B00H0</b>	<b>BL0T4C00H0</b>	<b>BL0T5B00H0</b>	-	-	-
-	BLCT2B00W0	-	BLCT3B00W0	BLCT4C00W0	BLCT5B00W0	-	-	-
-	BL0T2A00H0	-	BL0T3A00H0	BL0T4B00H0	BL0T5B00H0	-	-	-
-	BLCT2A00W0	-	BLCT3A00W0	BLCT4B00W0	BLCT5B00W0	-	-	-
-	<b>BL0T2B00H0</b>	-	<b>BL0T3B00H0</b>	<b>BL0T4C00H0</b>	<b>BL0T5B00H0</b>	-	-	-
-	BLCT2B00W0	-	BLCT3B00W0	BLCT4C00W0	BLCT5B00W0	-	-	-
-	BL0T2A00H0	-	BL0T3A00H0	BL0T4B00H0	BL0T5B00H0	-	-	-
-	BLCT2A00W0	-	BLCT3A00W0	BLCT4B00W0	BLCT5B00W0	-	-	-
-	<b>BL0T2D00H0</b>	-	<b>BL0T3D00H0</b>	<b>BL0T4D00H0</b>	<b>BL0T4D00H0</b>	<b>BL0T5D00H0</b>	<b>2 x BL0T4D00H0</b>	<b>2x BL0T5D00H0</b>
-	BLCT2D00W0	-	BLCT3D00W0	BLCT4D00W0	BLCT4D00W0	BLCT5D00W0	2 x BLCT4D00W0	2x BLCT5D00W0
-	BL0T2C00H0	-	BL0T3C00H0	BL0T4D00H0	BL0T4C00H0	BL0T5C00H0	2 x BL0T4C00H0	2x BL0T5C00H0
-	BLCT2C00W0	-	BLCT3C00W0	BLCT4D00W0	BLCT4C00W0	BLCT5C00W0	2 x BLCT4C00W0	2x BLCT5C00W0
-	<b>BL0T2D00H0</b>	-	<b>BL0T3D00H0</b>	<b>BL0T4D00H0</b>	<b>BL0T4D00H0</b>	<b>BL0T5D00H0</b>	<b>2 x BL0T4D00H0</b>	<b>2x BL0T5D00H0</b>
-	BLCT2D00W0	-	BLCT3D00W0	BLCT4D00W0	BLCT4D00W0	BLCT5D00W0	2 x BLCT4D00W0	2x BLCT5D00W0
-	BL0T2C00H0	-	BL0T3C00H0	BL0T4D00H0	BL0T4D00H0	BL0T5D00H0	2 x BL0T4D00H0	2x BL0T5D00H0
-	BLCT2C00W0	-	BLCT3C00W0	BLCT4D00W0	BLCT4D00W0	BLCT5D00W0	2 x BLCT4D00W0	2x BLCT5D00W0





## Heater humidifiers

Immersed heater humidification, complementary to the immersed electrode system, is becoming increasingly required in work specifications where:

- maximum hygiene possible is required (hospitals, operating theatres);
- humidity must be controlled precisely (museums, laboratories, clean rooms);
- quality of the water is not constant or is problematic (for example, aboard ships);
- periodical maintenance needs to be minimised (using demineralised water).

The immersed heater humidifiers, unlike the immersed electrode units, can operate on demineralised water, as they do not exploit the electrical conductivity of the water. Periodical maintenance can therefore be greatly reduced, due to the minimum formation of lime scale. Weighing against this, the resistive elements must always be completely immersed in the water, to avoid overheating (unlike the situation

with electrodes, in which the water level is adjusted to modulate the flow-rate of steam). The operation of an immersed heater humidifier then requires water level sensors (to ensure the complete immersion of the electrodes) and components (solid state relays) that precisely modulate the vapour flow-rate by applying electrical power with a variable duty cycle.

These characteristics make the heater units more complex than their counterparts with electrodes, yet independent of the characteristics of the water, and with much more precise modulation of the flow-rate.

In addition, as heater humidifiers are intrinsically subject to overheating, the quality of design and the presence of safety systems are essential to ensure reliable service over a maximum period of time.

The CAREL solution in this market segment offers the maximum in constructional quality and performance, meaning excellent reliability over time and extreme precision of control for the more critical applications.

CAREL solution for immersed heater humidifiers is **heaterSteam**.



Interface for the C control



Interface for the H and T controls



## Controllers

All the **heaterSteam** series humidifiers are available with three different types of control unit, with the following codes:

- **type “C”**: humidifiers with ON/OFF control managed by an external signal;
- **type “H”**: humidifiers with built-in control unit (modulating control);
- **type “T”**: humidifiers for specific use in steam baths.

### • Type C: ON/OFF control

This is the simplest model, fitted with an easy-to-understand icon-based display. The units with type C control operate at either 0% or 100% of the set maximum capacity.

The only programmable parameter is the steam production capacity, which can be set to 30%, 50%, 75% or 100% of the rated capacity of the humidifier.

### • Type H: modulating control, with built-in controller

The type H humidifiers are fitted with a built-in humidity control system, which must be connected to an external relative humidity probe for closed loop control.

The interface is used to set the set point and the differential, as well as many other parameters.

The differential (see the figure) is the interval within the probe signal in which the production of steam is proportional to the humidity demand.

If the relative humidity is less than the start of the proportional control band, production will be at 100% of the capacity of the unit, so as to reach the desired humidity level as quickly as possible.

After this, production decreases as the humidity level approaches the set point (proportional control band). Steam production is modulated continuously from 10% to 100% of the rated capacity of the humidifier, using solid state relays (SSR) to adapt the duty cycle.

To make the system even more flexible, the maximum level of production can be limited to a value from 10% to 100% of rated capacity.

In the units with type H control, the preheating function can be activated to ensure an immediate start of steam production when required.

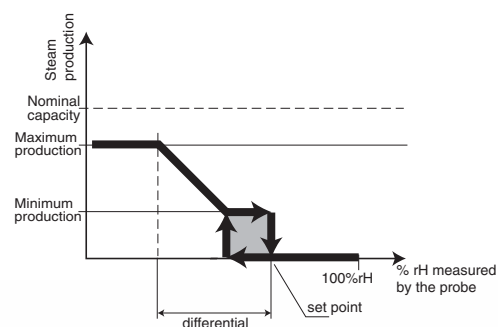

As an option, the units with type H control can be programmed to produce a quantity of steam that is proportional to a signal generated by an external controller (0 to 1 Vdc, 0 to 10 Vdc, 2 to 10 Vdc, 0 to 20 mA or 4 to 20 mA).

**heaterSteam** provides a clear indication of any malfunctions, thanks to a series of alarm codes and diagnostic indications. The numerous programmable operating parameters make model H extremely flexible, allowing the same unit to be used in a wide variety of situations. Up to 4 different humidifiers can be connected to a humivisor (see chapter accessories page 42), at a maximum distance of 1 km, for remote monitoring and setting the operating parameters. The parameters can also be programmed using an infrared remote control.

### • Type T: steam modulation according to the temperature

The model of **heaterSteam** with type T control has been developed for application in steam baths, where the production of steam is controlled according to the temperature. In steam baths, the relative humidity is always at saturation level (100%). The controller modulates the production of steam practically in the same way as model H, with the difference that production is controlled depending on temperature rather than the relative humidity. In this case too, the probe is not included.



## heaterSteam range

The new range of heaterSteam immersed heater humidifiers includes models producing from 2 to 60 kg/h of steam, and can operate on drinking water or demineralised water.

heaterSteam features exclusive technological solutions, such as the electric heaters embedded in corrosion-proof aluminium alloy casting with a large heat exchange surface, and built-in temperature sensors to prevent overheating.

For each model there are two variants: basic and “full option”.

The full option units have heat insulation around the boiler for maximum energy savings, and Teflon® coated heating elements to facilitate the separation of lime scale.

The heaterSteam range is available with 3 types of control:

- **H**, modulating with built-in controller (from active humidity probe);

- **T**, with temperature control (from external probe);
- **C**, for simple ON/OFF control.

The models from 2 to 10 kg/h have a cylindrical stainless steel boiler, which is easy to remove for cleaning; The larger models, from 20 to 60 kg, have a stainless steel boiler with a rectangular base and large openings (front and top) for easy maintenance; heaterSteam is particularly compact for its capacity. The smaller models, 2 and 4 kg/h, the only units of their type available, are the perfect solution for smaller applications in more prestigious environments (specialist clinics, professional studios) where high electrical power ratings are often not available. It is a matter of fact that the “duty cycle” modulation system of the heater units always means instant power consumption that is equal to the maximum flow-rate of the humidifier.

**For heaterSteam accessories refer to page 42.**





## Advantages

- the electric heaters are embedded in a corrosion-proof light alloy casting with a large surface area, guaranteeing perfect diffusion of the heat and exceptional reliability over time;
- temperature sensors inserted into the heating elements prevent any overheating, and detect well in advance the need for cleaning any lime scale deposits;
- Teflon coated heating elements (full option models) are very easy to clean;
- model H, with solid state relays, allows continuous modulation of steam production starting from 10% of capacity, with very precise control; model C provides ON/OFF operation;
- the patented AFS antifoam system prevents the release of any droplets of water together with the steam; type H control supports the limit probe to prevent any condensate forming in the duct;
- preheating function allows a rapid response;
- model H can also control a dehumidification device for even greater precision;
- electrical load is always perfectly balanced on the 3 phases.

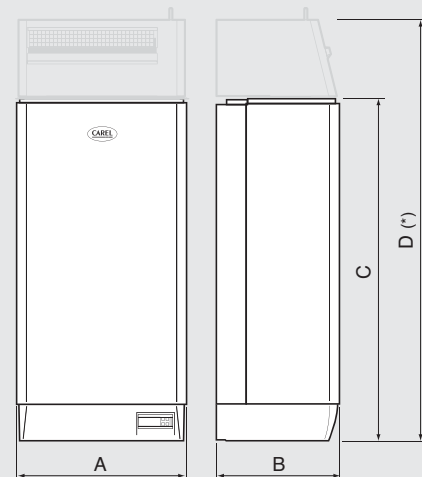

(\*) Height with top mounted ventilated steam distributor

Models	Humidifier dimensions				Packaging			
	A	B	C	D	A1	B1	C1	Weight
UR 2/4 kg	365	275	620	766	520	380	730	26
UR 6/10 kg	365	275	710	901	520	410	870	31
UR 20/27 kg	690	438	887	-	680	460	1090	73
UR 40 kg	690	438	887	-	680	460	1090	77
UR 60 kg	876	438	887	-	946	510	1050	98





## Models with cylindrical boilers

The heaterSteam 2 and 4 kg/h (single-phase) models, the 6 kg/h (single-phase and three-phase) model and the 10 kg/h (three-phase)

model, are all made with a cylindrical stainless steel boiler, which can be easily dismantled for cleaning outside of the unit. Every boiler features a level sensor and each heating element is protected by a PTC temperature sensor inserted in the light alloy casting. The “full option” models (code ending in 101) have Teflon® coated elements, insulation around the cylinder to limit the dispersion of heat, and a removable descaler on the inside, to simplify cleaning.

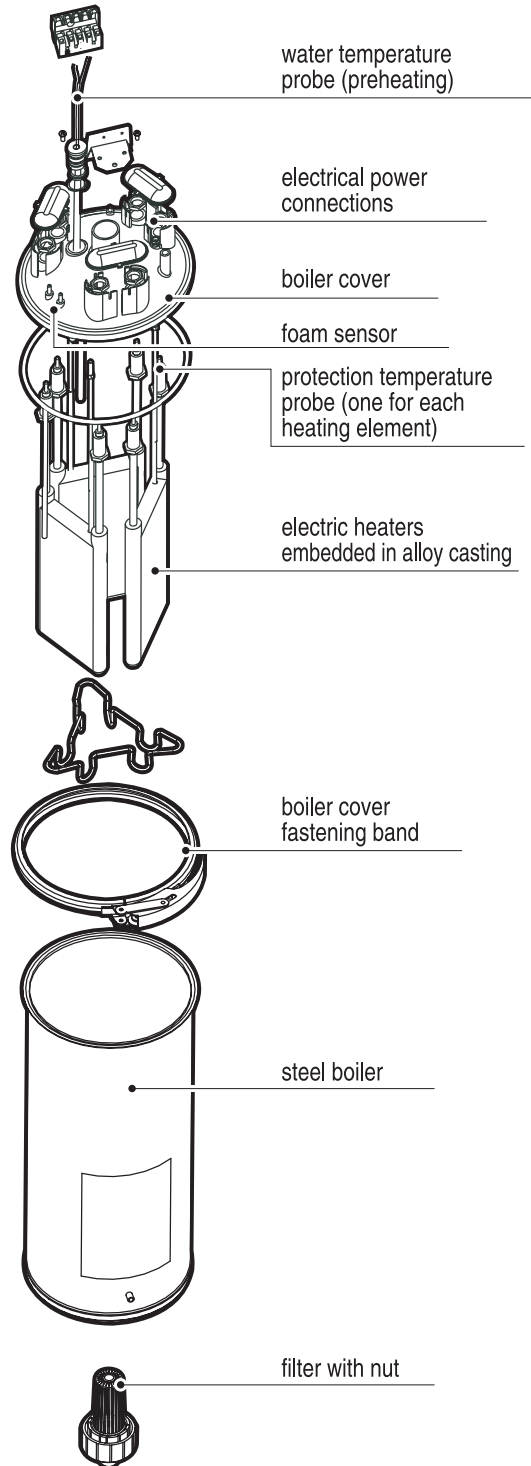
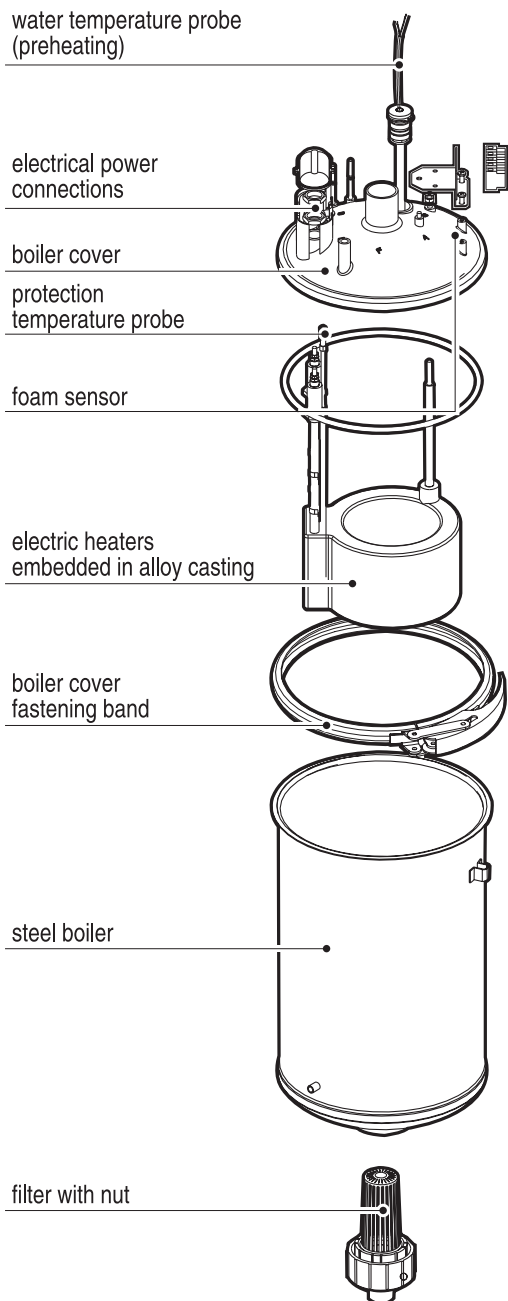

# Models with rectangular boilers

The heaterSteam 20, 27, 40 and 60 kg/h models feature, for maximum compactness, a boiler with a rectangular base, and with multiple heaters (9 for the 60 kg/h model, 6 for the other models). The “full option” models have Teflon® coated heaters and heat insulation around the boiler.

Cleaning is performed in these models by removing the large front cover of the boiler, which holds the electric drain pump and the scale filter.

The top too, which supports the heaters, is very easy to remove, as is the top panel of the body, guaranteeing optimum accessibility.



**Teflon-coated heaters** after 720 operating hours with water at 28 °F hardness (500 µS/cm). No manual cleaning has been performed. The layer of Teflon® assists the spontaneous separation of the lime scale, while the excellent heat conduction of the aluminium alloy avoids any localised overheating.

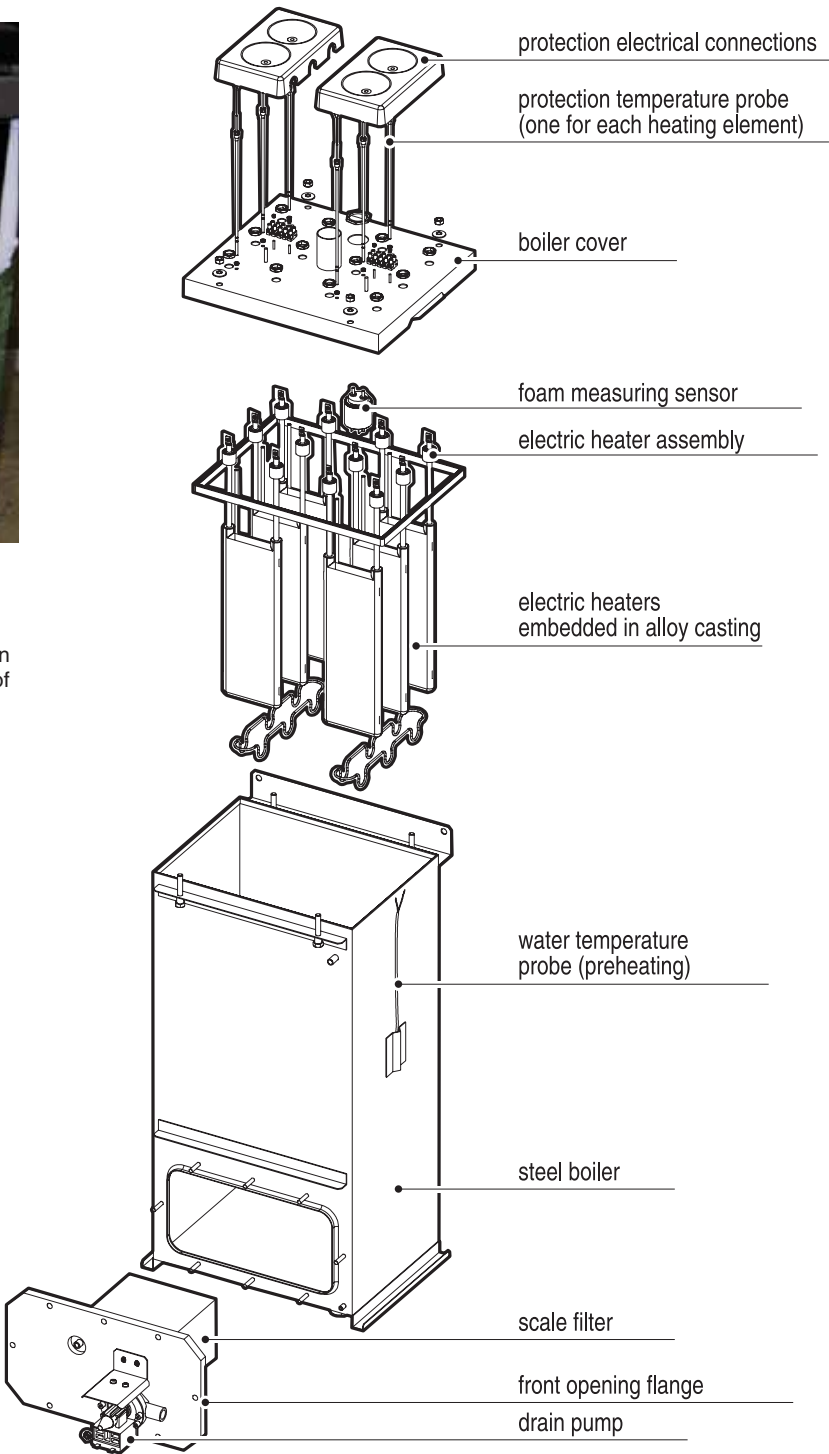

# OVERVIEW DRAWING

## duct applications

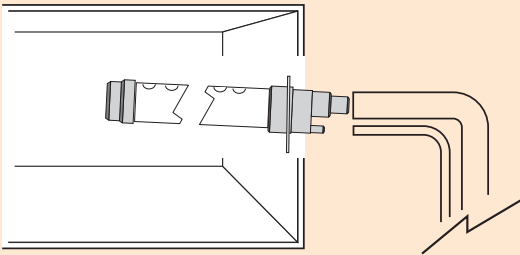

DP\*: linear steam distributor

## ambient applications

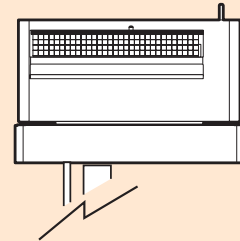

VSDU0A\*: ventilated steam distributor



URT\*: (humivisor):  
remote graphic display terminal  
and local supervisory unit

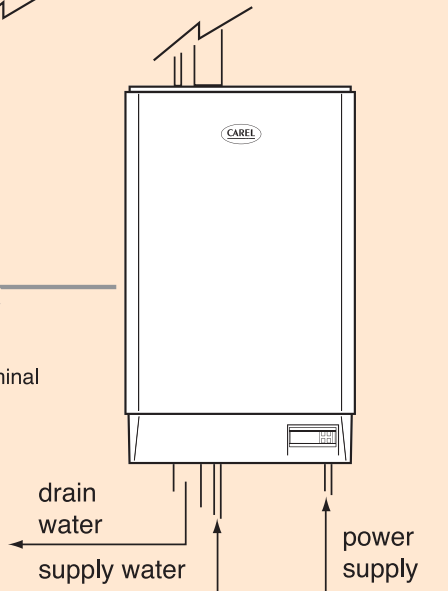

## Available probes



ASPC\*: industrial ambient  
temperature and humidity probe

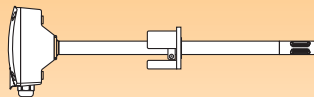

ASD\*: temperature and  
humidity duct probe



ASW\*: ambient temperature  
and humidity probe



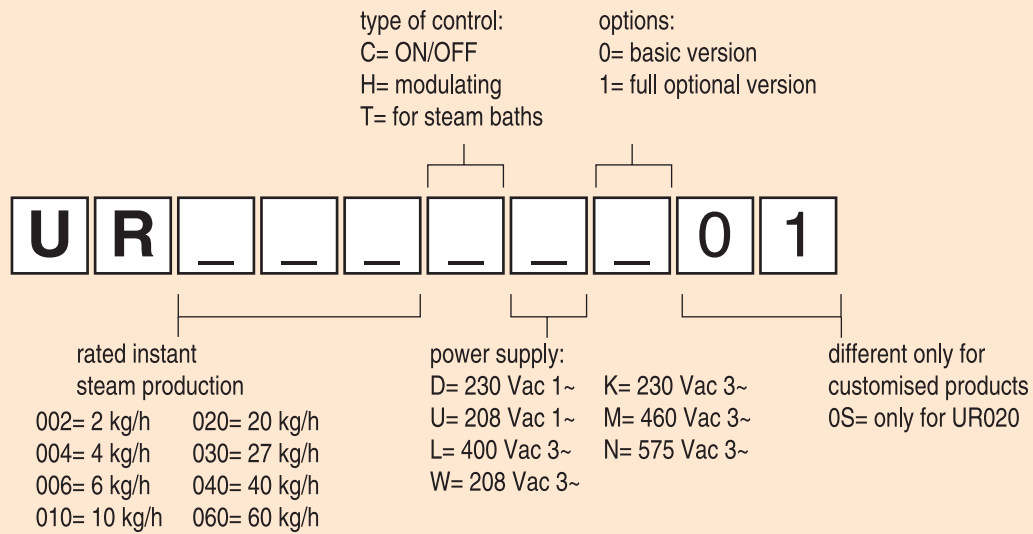

**Note:** that not all combinations of characters are available. Please contact CAREL distributors dealer for further information.

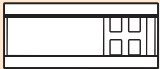

Control	URC	URH/URT
Inputs	contact ON/OFF	0 to 1 Vdc; 0 to 10 Vdc; 2 to 10 Vdc; 0 to 20 mA; 4 to 20 mA
Input impedance	-	60 kΩ with 0 to 1 Vdc; 0 to 10 Vdc; 2 to 10 Vdc signals; 50 Ω with 0 to 20 mA and 4 to 20 mA signals
Alarm relay	250 Vac, 8 A	250 Vac, 8 (2) A
Connections	-	RS485; Modbus <sup>®</sup> opt.; BACnet <sup>™</sup> opt.
Power to active probes		
– 24 Vdc (24 Vac rectified)	-	●
Imax 250 mA; 12 Vdc Imax 50 mA		
Remote enabling input		
– free contact; max resistance 50 Ω;	●	●
Vmax 24 Vdc; Imax 5 mA		

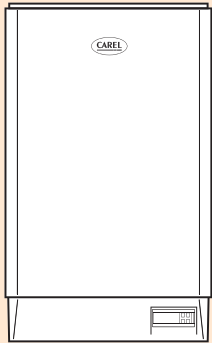

Model	UR002*	UR004*	UR006*
Rated steam production	2 kg/h	4 kg/h	6 kg/h
Power input	1.5 kW	3 kW	4.5 kW
Power supply			
– 208 or 230 Vac (-15% to +10%), 50/60 Hz, single-phase	●	●	●
– 208, 230, 400, 460, 575 Vac (-15% to +10%), 50/60 Hz, three-phase			●
Fitting	Ø 30	Ø 30	Ø 30
Steam pressure	0 to 1500 Pa	0 to 1500 Pa	0 to 1500 Pa
Number of heaters	1	1	3

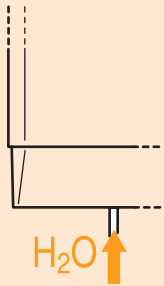

Fitting	3/4"G male		
Temperature limits	1T40 °C		
Water pressure limits	0.1 to 0.8 MPa - 1 to 8 bar		
Instant flow-rate	0.6 l/min	0.6 l/min	1.2 l/min
Total hardness	0 to 40 °fH		
Conductivity limits	0 to 1500 µS/cm		

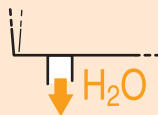

Fitting	Ø 40		
Temperature	<100 °C		
Instant flow-rate	5 l/min	5 l/min	5 l/min

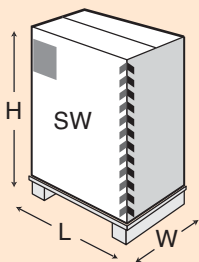

Humidifier (LxWxH)	365x275x620 mm	365x275x620 mm	365x275x710 mm
Weight (empty)	21 kg	21 kg	26 kg
Packaging (LxWxH)	520x380x730 mm	520x380x730 mm	520x410x870 mm
Weight of packaged humidifier (SW)	26 kg	26 kg	31 kg
Operating conditions	1T40 °C, 10 to 90% rH non-cond.		
Storage conditions	-10T70 °C, 5 to 95% rH non-cond.		
Index of protection	IP20		

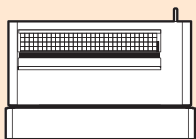

Ventilated distributor VSDU0A	●	●	●
Power supply / rated power	230 Vac / 30 W	230 Vac / 30 W	230 Vac / 30 W
Rated air flow	170 m³/h	170 m³/h	170 m³/h



Control	URC*/URH*/URT*		
---------	----------------	--	--



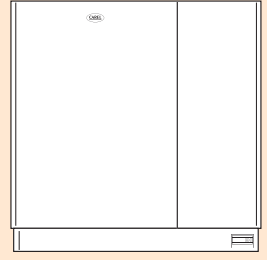
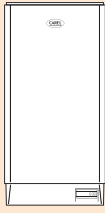

UR010*	UR020*	UR027*	UR0040*	UR060*
10 kg/h	20 kg/h	27 kg/h	40 kg/h	60 kg/h
7.5 kW	15 kW	22.5 kW	30 kW	45 kW
●	●	●	●	●
Ø 30	Ø 40	Ø 40	Ø 40	Ø 40
0 to 1500 Pa	0 to 3600 Pa	0 to 3600 Pa	0 to 2350 Pa	0 to 2350 Pa
3	6	6	6	9
3/4"G male				
1T40 °C				
0.1 to 0.8 MPa - to 8 bar				
1.2 l/min	4 l/min	4 l/min	4 l/min	10 l/min
0 to 40 °Fh				
0 to 1500 µS/cm				
Ø 40				
<100 °C				
5 l/min	22.5 l/min	22.5 l/min	22.5 l/min	22.5 l/min
365x275x710 mm	690x438x887 mm	690x438x887 mm	690x438x887 mm	876x438x887 mm
26 kg	63 kg	63 kg	67 kg	87 kg
520x410x870 mm	680x460x1090 mm	680x460x1090 mm	680x460x1090 mm	946x510x1050 mm
31 kg	73 kg	73 kg	77 kg	98 kg
1T40 °C, 10 to 90% rH non-cond.				
-10T70 °C, 5 to 95% rH non-cond.				
IP20				
●	—	—	—	—
230 Vac / 30 W	—	—	—	—
170 m³/h	—	—	—	—
URC*/URH*/URT*				



## Gas-fired humidifiers

To generate 1 kg of steam at atmospheric pressure, considering all the various factors, requires around 750 Wh of energy, either electrical or from other sources.

One of the main factors when choosing solutions in the field of isothermal humidification is therefore the cost of energy, particularly for heavy-duty uses (for example: the food industry and air-conditioning installations in large environments with 24 hour operation). From this point of view, the use of gas as the source of thermal energy is the ideal solution, because gas is now widely available in most places, and its price per kWh, despite varying greatly from country to country, is always much lower than that of electricity. To completely exploit this advantage in terms of energy costs, a system with high thermal efficiency is required, capable of minimising the loss of heat; for peace of mind from a safety point of view, the system must be made up of tried and tested components and complete control systems certificated according to the strictest international standards. For this reason, CAREL has developed the **gaSteam** range of humidifiers in collaboration

with Ecoflam, a manufacturer with vast know-how and extensive experience in the production of gas systems.

### Cost competitiveness

Even considering the higher purchase price compared to an electrical humidifier, the break even point for gas-fired humidifiers is reached quite quickly, typically in less than two years, but in many cases even earlier. After this, the system ensures significant savings in running costs, reaching surprising levels in just a few years.

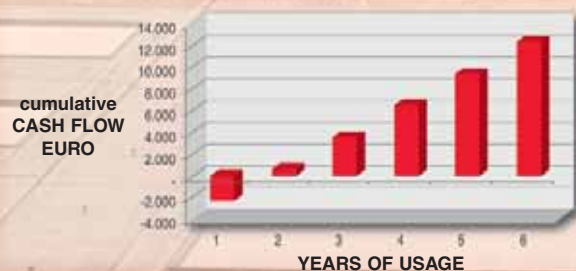

Comparison of **gaSteam** with an immersed electrode humidifier in terms of total cash flow in , including the costs of purchase, energy and maintenance. Positive values correspond to savings with the gas solution compared to the electrical appliance.

This graph is based on 2000 operating hours/year, and with the costs of gas and electricity applied in Italy; in many other European countries, the situation is even more advantageous, due to the greater gap between the prices of gas and electricity.



**Key:**

1. water tap with non-return device
2. fill valve
3. antifoam sensor
4. boiler
5. electrical panel with display
6. flue gas temperature sensor
7. water level sensor
8. preheating temperature sensor
9. heat exchanger
10. gas tap
11. gas burner
12. drain tap
13. water drain filter
14. drain pump
15. conductivity sensor

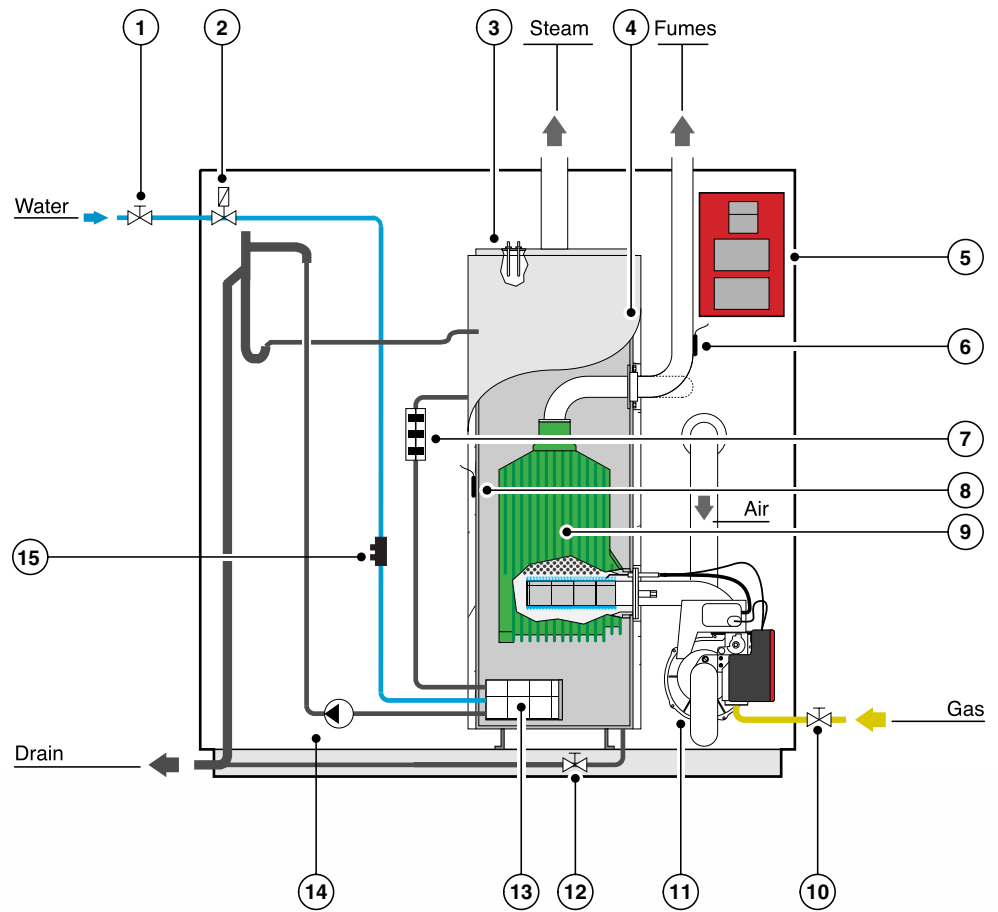

**Certification**

CAREL has paid significant attention to the certification of **gaSteam**, so as to be able to guarantee the complete safety of the product and achieve all major certification.

gaSteam is approved according to the European CE standards, the German TÜV standards and the American ETL standards. For Europe, specific DVGW certification has been obtained for units operating on gas.

In addition, **gaSteam** is approved as a class 5 appliance thanks to the low flue NOx, allowing it to be installed in countries with very strict legislation in force.

As regards the applications refer to the following:

- 90/396/EEC standard;
- for the premises subject to the certification of the appointed bodies, the reference standard is: D.M. 12<sup>nd</sup> April 1996;
- for the gas line the reference is: UNI - CIG 7129 dated 1972.

**Safety**

**gaSteam** is fitted with various safety devices, including:

- an air/gas control valve with double closing, to prevent the possibility of gas leaks;
- temperature control of the flue gas, with alarm signal and shut-down of the appliance in the event of incorrect operation;
- a flame detector in the burner that closes the gas valve in the event of operating anomalies;
- a minimum water level sensor that ensures the correct level of water inside the boiler;
- an auxiliary safety thermostat in the event of the malfunctioning of the water level sensor (thermostats with manual reset).



## gaSteam range

CAREL's extensive experience in the humidification sector, combined with Ecoflam technology in the field of gas heating, has allowed the development of the gaSteam range of gas-fired humidifiers. The range includes the 40 kg/h model (45 kg/h for the American market) and the new 90 kg/h and 180 kg/h models, covering all humidification requirements, and is certified by the main international safety organisations, including TÜV-DVGW (Germany) and ETL (USA).

gaSteam is installed in the same way as a normal domestic heating system, can operate either on natural gas or LPG, and is suitable for use with demineralised water to limit periodical maintenance.

Ideal for heavy-duty uses, gaSteam offers exceptional savings in operating costs over time compared to electrical humidifiers, exploiting the price difference (for the same

energy content) between gas and electricity, which despite varying according to the country, is always significant.

The result of a specific design developed in partnership with Ecoflam, this unit offers unrivalled energy efficiency – between 92 and 95%, depending on the model – and advanced technological solutions, such as the removable heat exchanger and the stainless steel boiler that is easily openable for maintenance.

The flow-rate of steam delivery can be modulated continuously between 25% and full capacity, for maximum precision in humidity control.

The 180 kg/h model has two burner assemblies and identical exchangers, allowing modulation starting from 12.5% of the maximum flow-rate.

**For the gaSteam accessories refer to page 42.**



**Heat exchanger** (model 90 kg/h): easily removable, made from light corrosion-proof alloy with Teflon® coating.

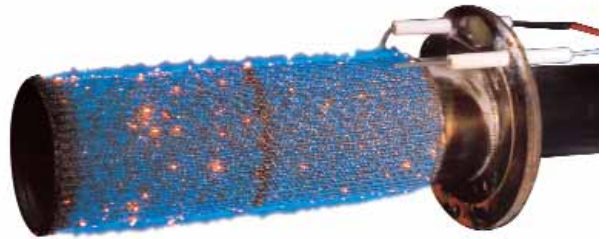

**Burner head** (model 90 kg/h): ignition device and flame sensor included.

The controller adjusts the production of steam by managing the burner fan. The gas inlet valve consequently controls the flow of the gas. The flame sensor manages both the automatic ignition device and the gas valve: when there is no flame, the flow of gas is stopped.

## Advantages

- **Great savings in running costs over time** compared to an electrical humidifier;
- redundant **safety devices: level sensor** protecting the exchanger and **temperature sensor** inserted in the flue gas outlet signals any excess lime scale deposits and **prevents overheating**;
- **pre-mix**, jet burner with very low NOx emissions (class 5);
- **easily removable heat exchanger**, in light corrosion-proof alloy casting, Teflon® coated to prevent lime scale deposits;
- **very high energy efficiency**: from 92 to 95%, according to the model;
- **modulating production continuously** from 25% to the max flow-rate (model 180: from 12.5%);
- **openable stainless steel boiler**;
- **burns natural gas** (G20 or G25), **propane** (G30) or **butane** (G31): does not require the replacement of parts during installation;
- can run on **demineralised water or mains water** with maximum hardness 40 °fH and conductivity up to 1,500 µS/cm;
- **built-in controller**, also supports ON/OFF or proportional operation from an external controller;
- supports **second limit probe** for ducts;
- **preheating function** for a faster response.
- the **patented AFS antifoam system** prevents the release of any droplets of water together with the steam; the control supports the limit probe to prevent any condensate forming in the duct.

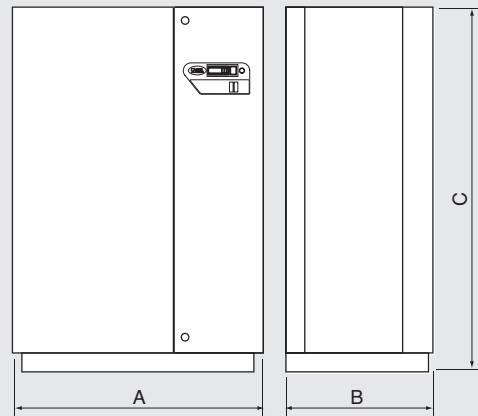

Models	Humidifier dimensions			Packaging			
	A	B	C	A1	B1	C1	Weight
UG 40 kg/h	900	500	1200	980	600	1430	137
UG 90 kg/h	1020	570	1200	1100	670	1430	165
UG 180 kg/h	1020	930	1200	1100	1030	1430	230

# OVERVIEW DRAWING

## duct applications

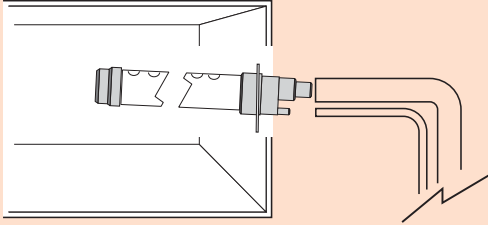

SPD\*: linear steam distributor

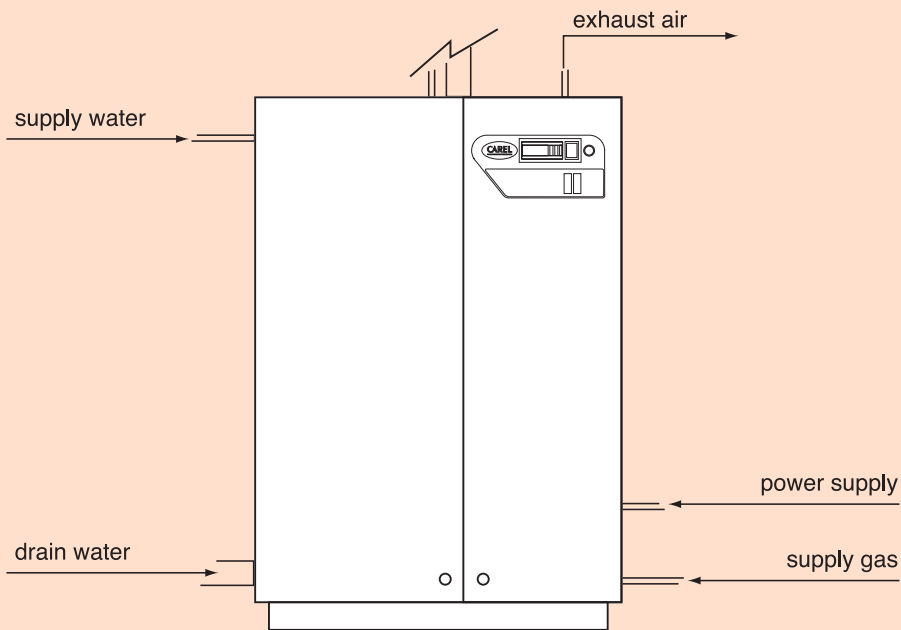

## Available probes



ASPC\*: industrial ambient temperature and humidity probe

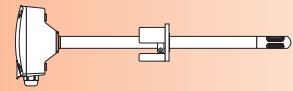

ASD\*: temperature and humidity duct probe



ASW\*: ambient temperature and humidity probe

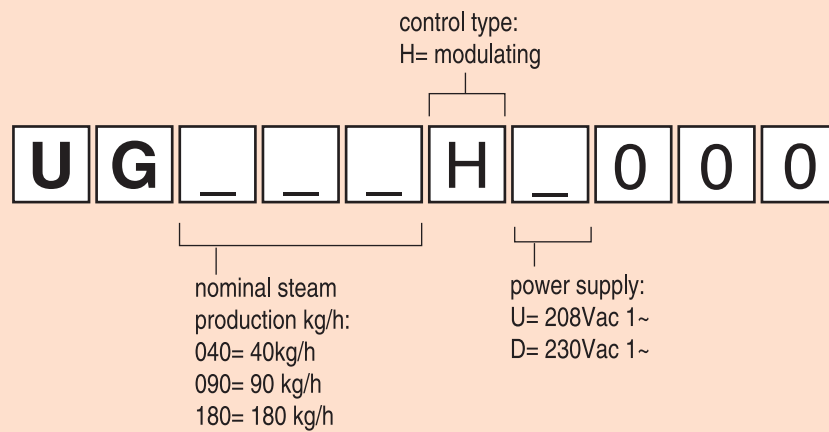

**Note:** that not all combinations of characters are available. Please contact CAREL dealer for further information.



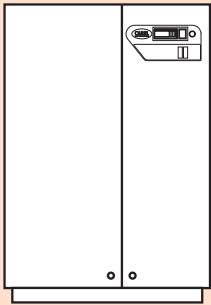
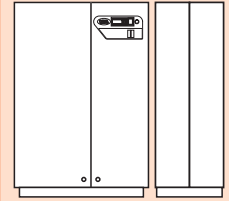
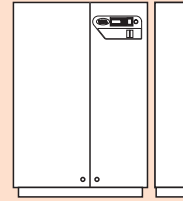
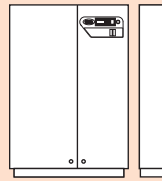

Model	UG040*	UG090*	UG180*
Instant steam production	40 kg/h	90 kg/h	180 kg/h
Maximum energy production	29 kW	68 kW	136 kW
Steam fitting	Ø 40	2x Ø 40	4x Ø 40
Max. steam pressure	0 to 2000 Pa		
Power supply	230 Vac, 50/60 Hz		
Power consumption	80 W	285 W	400 W
Types of gas	natural gas (G20 and G25); propane (G31); butane (G30)		
Gas fitting	3/4" G male (kit supplied with 3/4"G female tap)		

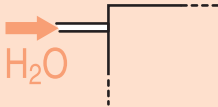

Fitting	3/4"G male
Temperature limits	1T40 °C
Water pressure limits	0.1 to 0.8 MPa - 1 to 8 bar
Instant flow-rate	10 l/min
Total hardness	0 to 40 °fH

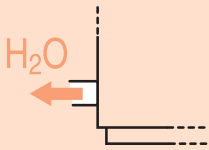

Fitting	Ø 40
Temperature	<100 °C
Instant flow-rate	30 l/min

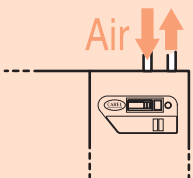

Air inlet pipe	Ø 80	Ø 2x80	
Flue	Ø 80	Ø 2x80	
Flue gas flow-rate (natural gas)	0.015 kg/s	0.032 kg/s	0.064 kg/s
Flue gas temperature	110 °C	165 °C	165 °C
NOx emissions	class 5 (NOx < 70 mg/kWh)		

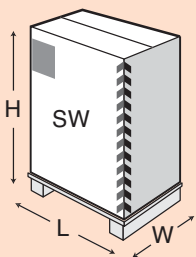

Humidifier (LxWxH)	900x500x1200 mm	1020x570x1200 mm	1020x930x1200 mm
Weight (empty)	125 kg	150 kg	210 kg
Packaging (LxWxH)	980x600x1430 mm	110x670x1430 mm	1100x1030x1430 mm
Weight of packaged humidifier (SW)	137 kg	165 kg	230 kg
Opening conditions	1T40 °C, 10 to 90% rH non-cond.		
Storage conditions	-10T70 °C, 5 to 95% rH non-cond.		
Index of protection	IP20		



Control by probe; proportional; ON/OFF



Network connection RS485; Modbus® (with opt. Gateway); BACnet™ (with opt. Gateway)



## Centralised steam distributors

The *ultimateSteam* direct steam humidifiers are designed to receive pressurised steam from a centralised system, treat it to remove all the condensate, and finally distribute the dry steam directly into the duct or air handling unit.

*ultimateSteam* is covered by various patents, and ensures excellent performance for use in the more critical conditions, above all where limited distance is available for the absorption of the steam.

The steam flow-rate ranges from 1 to 900 kg/h, while the dimensions vary from 305 mm to 3050 mm in both width and height.

*ultimateSteam* can be supplied complete with steam valve and electronic or pneumatic actuator, as well as a condensate drain.

### Advantages

- **Minimum absorption distance:** the outlet of steam through continuous slits (rather than through nozzles, as in most of the competing systems) creates a thin layer of steam that flows uniformly from both sides of the distributor, creating a large surface of contact with the air, allowing a minimum absorption distance (typically half the distance of conventional systems);
- **minimum leaks due to condensation:** the distributors are coated with a layer of very high tech ceramic insulation (deriving from aerospace applications), which reduces by up to 90% the losses due to condensate and the heating of the surrounding air. The lining of the distributor, 0.8 mm thick, reduces the temperature of the outside surface to no more than 50 °C, even when the steam inside reaches 120 °C. This insulation also allows lower steam pressure to be used, with advantages both in economic and safety terms;
- **no emission of droplets of condensate:** the vertical distributors feature a special herringbone condensate separator, which traps and returns any droplets of condensate back to the centre, where these evaporate again;
- **long periods without maintenance:** all the parts of the distributor are made from steel, without gaskets, nozzles or plastic parts that may be affected by thermal stress.

## Functions

The **ultimateSteam** direct steam humidification system includes:

- the **ultimateSteam** supply manifold (top and/or bottom);
- vertical distribution manifolds;
- steam inlet filter and pipes;
- steam valve with pneumatic or electronic control;
- thermostat socket with float.



## Method of installation

### With trap and controller outside the duct

In this example, the **ultimateSteam** system is made based on the dimensions of the duct, with reference to the nominal dimensions of the **ultimateSteam** unit. This method allows the lowest possible distance of evaporation.

**Example:** For a duct measuring 1245x864 mm, an **ultimateSteam** humidifier with nominal dimensions of 1220x610 mm is used. For a duct measuring 1220x915 mm, an **ultimateSteam** humidifier with nominal dimensions of 1220x915 mm is used.

### With trap controller inside the duct or air handling unit

In this example, the **ultimateSteam** system is sized based on the dimensions of the duct, with reference to the nominal dimensions of the **ultimateSteam** unit, less one size in width and in height.

**Example:** For an air handling unit measuring 1854x1651 mm that requires a DSB model, a DSB **ultimateSteam** humidifier with nominal dimensions of 1524x1220 mm is used. If a DST model is required (manifold supplied from above), a DST **ultimateSteam** humidifier measuring 1220x915 mm is used.

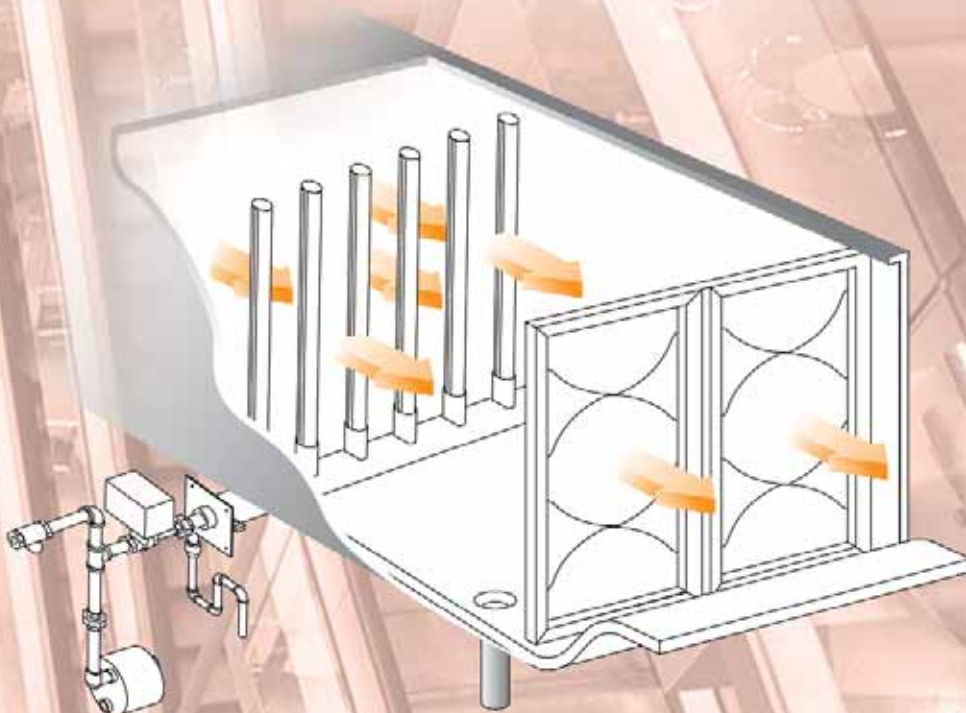





installation without gaskets condensate manifold

Airflow

Steam

## ultimateSteam range

From 1 to 900 kg/h

- steam valve with pneumatic control
- steam valve with electronic control
- Works with centralised steam, from 0.15 to 1 bar;
- variable-pressure steam outlet (PVA) for the lowest possible evaporation distance;
- patented insulation to reduce the loss of condensate and limit the heating of the air ducts;
- dimensions from 305x305 mm to 3050x3050 mm.

Multi-manifold rapid absorption type DSB\* bottom fed

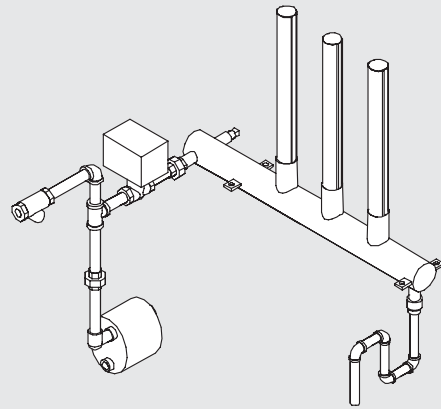

Single manifold traditional type DS0\*

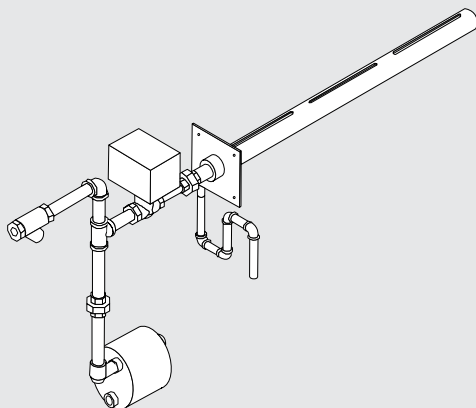

Multi-manifold rapid absorption type DST\* top fed

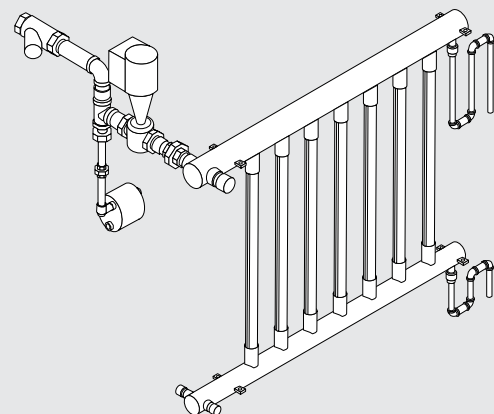



Duct/AHU width (mm) - 0 with UST single

A= 300 C= 600 E= 1200 G= 1800 I= 2400 M= 3000  
 B= 450 D= 900 F= 1500 H= 2100 L= 2700

Required capacity (kg/h)

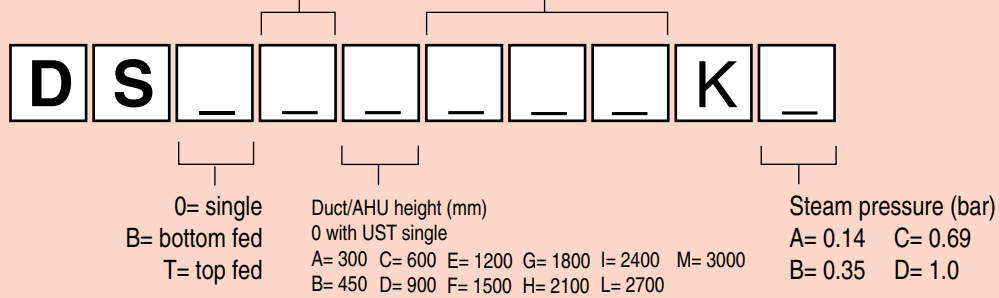

## Model capacities

		Nominal Width – mm												
Key		300*	450*	600	900	1200	1500	1800	2100	2400	2700	3000		
Nominal Height - mm	300*	A	457x305	610x305	762x305	1067x305	1372x305	1676x305	1981x305	2286x305	2591x305	2896x305	3200x305	
		B	68	68	102	136	170	205	239	246	246	246	246	
		C	N/A	N/A	N/A	N/A	N/A	N/A	N/A	N/A	N/A	N/A	N/A	
		450*	A	457x451	610x451	762x451	1067x451	1372x451	1676x451	1981x451	2286x451	2591x451	2896x451	3200x451
		B	68	68	102	136	170	205	239	246	246	246	246	
		C	N/A	N/A	N/A	N/A	N/A	N/A	N/A	N/A	N/A	N/A	N/A	
		600	A	457x451	610x451	762x451	1067x451	1372x451	1676x451	1981x451	2286x451	2591x451	2896x451	3200x451
		B	68	68	102	136	170	205	239	246	246	246	246	
		C	N/A	N/A	N/A	N/A	N/A	N/A	N/A	N/A	N/A	N/A	N/A	
		900	A	457x806	610x806	762x806	1067x806	1372x806	1676x806	1981x806	2286x806	2591x806	2896x806	3200x806
		B	68	68	102	136	170	205	239	246	246	246	246	
		C	N/A	N/A	N/A	455	545	636	727	818	909	985	985	
		1200	A	457x1111	610x1111	762x1111	1067x1111	1372x1111	1676x1111	1981x1111	2286x1111	2591x1111	2896x1111	3200x1111
		B	68	68	102	136	170	205	239	246	246	246	246	
		C	N/A	N/A	N/A	455	545	636	727	818	909	985	985	
		1500	A	457x1416	610x1416	762x1416	1067x1416	1372x1416	1676x1416	1981x1416	2286x1416	2591x1416	2896x1416	3200x1416
		B	68	68	102	136	170	205	239	246	246	246	246	
		C	N/A	N/A	N/A	455	545	636	727	818	909	985	985	
		1800	A	457x1721	610x1721	762x1721	1067x1721	1372x1721	1676x1721	1981x1721	2286x1721	2591x1721	2896x1721	3200x1721
		B	68	68	102	136	170	205	239	246	246	246	246	
		C	N/A	N/A	N/A	455	545	636	727	818	909	985	985	
		2100	A	457x2026	610x2026	762x2026	1067x2026	1372x2026	1676x2026	1981x2026	2286x2026	2591x2026	2896x2026	3200x2026
		B	68	68	102	136	170	205	239	246	246	246	246	
		C	N/A	N/A	N/A	455	545	636	727	818	909	985	985	
		2400	A	457x2330	610x2330	762x2330	1067x2330	1372x2330	1676x2330	1981x2330	2286x2330	2591x2330	2896x2330	3200x2330
		B	68	68	102	136	170	205	239	246	246	246	246	
		C	N/A	N/A	N/A	455	545	636	727	818	909	985	985	
		2700	A	457x2635	610x2635	762x2635	1067x2635	1372x2635	1676x2635	1981x2635	2286x2635	2591x2635	2896x2635	3200x2635
		B	68	68	102	136	170	205	239	246	246	246	246	
		C	N/A	N/A	N/A	455	545	636	727	818	909	985	985	
		3000	A	457x2940	610x2940	762x2940	1067x2940	1372x2940	1676x2940	1981x2940	2286x2940	2591x2940	2896x2940	3200x2940
		B	68	68	102	136	170	205	239	246	246	246	246	
		C	N/A	N/A	N/A	455	545	636	727	818	909	985	985	

### Item key:

A = Actual widthxheight - mm

B = USTD maximum capacity - kg/h

C = USTDDBL maximum capacity - kg/h

\*: 300 mm and 450 mm models MUST be mounted with the traps and valve outside of the duct.



## Accessories

**These accessories are valid for the humiSteam, homeSteam, heaterSteam and gaSteam.**

The CAREL range of accessories for isothermal humidifiers have been especially developed to allow the designer to create humidification systems that are complete and suitable for all types of application.

The fundamental idea is to guarantee the optimum operation of the humidification system by providing the installer, maintenance personnel and user all the auxiliary components that simplify installation, the distribution of steam, operation and control of the humidifier.

The accessories, described in the following paragraphs, are divided into:

- steam distribution accessories: steam pipes and distributors, for rooms and ducts;
- plumbing components, for filling and draining the water;
- humivisor and remote controls, for clear and immediate control of the operation of the humidifier;
- probes and external controllers (described in the chapter “Probes and control devices”).



## Ducted steam distributors

DP\* e DN\*

A completely upgraded range of linear steam distributors for ducts is available, replacing the previous two aluminium and steel lines. The new “DP” line is made from perforated stainless steel pipes supported by a fastening bracket in Rytan®. This material combines excellent mechanical characteristics with extraordinary resistance to high temperatures. The new fastening bracket allows the steam distributor to be fastened

vertically to a wall, guaranteeing the correct incline of the distributor for the drainage of the condensate.

The stainless steel linear steam distributors are available in 3 different diameters (35, 45 and 60 mm), which couple respectively to the 22, 30 and 40 mm diameter steam hoses used on the entire range of CAREL humidifiers.

The linear distributors are designed to release the steam in a uniform manner along the entire length of the distributor, so as to minimise the absorption distance, without however interfering with the correct operation of the humidifier that, it should be remembered, has a maximum back-pressure that cannot be exceeded.

The table describes the recommended models for each type of humidifier; the sizes in brackets (double) are to be used in the event of small ducts, however require the branching of the steam hoses. A new range of steam nozzles is available for the steam distribution in little ducts (DN2200000, DN3000000 and DN4000000).

distributor code	Ø inlet	section	length	UE001	UR002	UE003	UR004	UE005	UR006	UE008	UE010	UR010	UE015	UR020	UE025	UR027	UE035	UR040	UG040	UE045	UR060	UE065	UE090	UG090	UE130	UG180	
DP035D22R0	22 mm	35 mm	350	1		1																					
DP045D22R0			450	1		1																					
DP060D22R0			600	1		1																					
DP085D22R0			850	1		1																					
DP035D30R0	30 mm	45 mm	350		1		1	1																			
DP045D30R0			450		1		1	1	1	1																	
DP060D30R0			600				1	1	1	1	1	1	1														
DP085D30R0			850							1	1	1	1	1		(2)											
DP105D30R0			1050									1	1	1		(2)		(2)									
DP125D30R0			1250											1		(2)		(2)									
DP085D40R0	40 mm	60 mm	850											1	1	1	(2)	(2)	(2)	(2)	(4)	(4)					
DP105D40R0			1050											1	1	1	1	(2)	(2)	(2)	2	2	(4)		4		
DP125D40R0			1250											1	1	1	1	1	1	1	2	2	2	2	4	4	
DP165D40R0			1650													1	1	1	1	1	2	2	2	2	4	4	
DP205D40R0			2050																1	1	1			2	2		4

## Steam linear distributors for ambient

Linear steam distributors are used for steam distribution in duct installations. These models are being phased out and will be replaced by the DP\* models on the previous page.



### Stainless-steel linear steam distributors

The stainless steel linear distributors (SDP\*) are made in AISI304 steel and are supplied complete with mounting bracket for installation in duct. The distributors are formed from two concentric pipes, allowing an even steam distribution in the duct.



### Aluminium linear steam distributors

These distributors (SDP\*E\*) are made in aluminium and plastic and are lighter than the distributors made in stainless steel. The distributors in aluminium can easily be cut and adapted to the required dimensions of the duct they are installed in.



### Plastic nozzles

The plastic nozzles are made in hard plastic and developed for steam distribution in small ducts and for special applications. These models are being phased out and will be replaced by the DN\* models on the previous page.

STAINLESS STEEL DISTRIBUTORS											
description	Lmm	Ømm	UE001	UE003	UE005	UE008	UE010	UE015	UE025	UE035	UE045
9995805*	250	22	1	1							
9995807*	350	22	1	1							
9995809*	550	22	1	1							
9995804*	450	30		1	1	1					
9995806*	550	30		1	1	1	1	1	2	2	2
9995808*	750	30		1	1	1	1	1	2	2	2
9995810*	950	30		1	1	1	1	1	2	2	2
9995812*	1150	30		1	1	1	1	1	2	2	2
9995803*	1600	30			1	1	1	1	2	2	2
9995814*	2000	30				1	1	1	2	2	2
9995871*	850	40							1	1	1
9995872*	1050	40							1	1	1
9995873*	1250	40							1	1	1
9995874*	1600	40							1	1	1
9995875*	2000	40							1	1	1

ALLUMINIUM AND PLASTIC DISTRIBUTORS											
description	Lmm	Ømm	UE001	UE003	UE005	UE008	UE010	UE015	UE025	UE035	UE045
SDP30E	300	22/30	1	1							
SDP45E	450	22/30	1	1	1	1	1	1			
SDP65E	650	22/30	1	1	1	1	1	1	2(*)	2(*)	2(*)
SDP85E	850	22/30		1	1	1	1	1	2(*)	2(*)	2(*)
SDP120E	1200	22/30		1	1	1	1	1	2(*)	2(*)	2(*)

(\*) using a "Y" connector 13C478A085

PLASTIC NOZZLES											
description	Lmm	Ømm	UE001	UE003	UE005	UE008	UE010	UE015	UE025	UE035	UE045
SDPOEM12	--	22/30	1	1							
SDPOEM22	--	22/30			1	1	1	1			



## Ventilated steam distributors

The ventilated steam distributors (VSDU0A0001) are used for the distribution of steam directly into the rooms being humidified.

The ventilated distributor can be fitted directly onto the humidifier, or in a remote position. In the latter case, a support is required for mounting the fan (VSDBAS0000), as well as a pipe to connect the fan to the humidifier (see below).

The ventilated steam distributor works in ON/OFF mode, and is controlled by a thermal device that is activated when steam is produced. When the production of steam ceases, the ventilated distributor continues to operate for a short time to avoid condensation of the remaining steam.

The manual louver allows the flow of steam to be directed so as to avoid condensation on the ceiling or other objects, while the plastic tank at the bottom of the distributor collects any condensate.



## Steam pipes and hoses

1312360AXX - 1312365AXX - 1312367AXX: pipe for cylinders with 22/30/40 mm fitting and harmonic steel coil (outside diameter 32/41/52 mm)

The new steam distribution hoses are made from rubber resistant to 105 °C in continuous operation without the emission of odours, and suitable for use with foodstuffs.

The harmonic steel coil immersed in the rubber gives the hose flexibility and strength, preventing it from being choked and blocking the flow of steam.





## Fill pipes and hoses

FWH3415000: hose

999572\*ACA: straight and 90° quick connection

1312350APN: hose with 6 mm ID and 8 mm OD

FWHDCV0000: water fill kit

The new water supply hose is an essential component for avoiding the breakage of the fill valve due to direct connection to the metal mains water pipes. The hose is 1.5 metres long, with two female 3/4" GAS fittings (straight + 90°). Alternatively, the 6 mm pipe and the quick connectors described below can be used.

The straight or 90° connection is screwed onto the fill electrovalve and can be quickly fitted by tightening a nut to the 6 mm water fill hose.

The kit includes the hose and a double non-return valve. The kit has been designed both to ensure conformity to standards that require the use of a double non-return valve upstream of the humidifier, and to avoid breakages of the fill valve due to direct connection to the metal mains water pipes.



## Drain pipes and hoses

1312353APG: condensate drain pipes

1312357APG: water drain hose (1 m)

The condensate drain pipe, the same for all humidifiers, must be used to drain the condensate that forms inside the ventilated steam distributors and the ducted linear distributors.

The water drain pipe is the same for all isothermal humidifiers and is made from rubber resistant to 100 °C.



## humivisor: remote terminal with graphic display

URT0000000

The humivisor remote terminal with graphic display manages a local network made up of a maximum of 4 humidifiers from the humiSteam, heaterSteam, gaSteam and humiFog series.

The network connection requires the use of a RS485 serial link with two wires and daisy-chain configuration. This terminal can be used for the centralised display and setting of the status and parameters for each humidifier, making the supervision and control of the network simple and fast.

The display is backlit, and the contrast can be adjusted to allow reading in any conditions. The terminal is fitted with a clock used to set the weekly ON/OFF times for all the humidifiers in the network.



## Remote control

TELU\*0\*000

A remote control is available for the remote programming of most of the humidifiers with modulating control: heaterSteam, humiSteam, gaSteam and humiFog.

The remote control is available in the English or Italian version.



# **Adiabatic humidifiers**

---



## Pressurised water atomisers

*humiFog* represents a new generation of economical adiabatic atomisers with a power input of just 4 Watts for each litre/hour of atomised water.

The new atomising humidifier pumps water at high pressure through stainless steel nozzles to produce a very fine and uniform fog.

The *humiFog* system, unlike the classic air/water atomisation systems, does not require the use of a compressor or the installation of a compressed air line. In addition, as a further guarantee of hygiene, *humiFog* does not atomise recirculated water, in compliance with the main guidelines and international standards (ASHRAE 12-2000, VDI 6022, VDI 3803, L8).

### Advantages

- **Versatility:** *humiFog* is suitable for ambient, multi-zone and ducted humidification;
- **adiabatic humidifier:** humidifies and cools the air (up to -10 °C cooling);
- **atomisation:** very fine, uniform, clean (demineralised water) and economical (without compressed air);
- **wide range of models for all requirements:**
  - *with inverter:* can be configured to humidify in the duct or to supply water at a constant pressure, with high precision;
  - *without inverter:* this mode is suitable for ambient or multi-zone humidification with special requirements in terms of precision;
- **atomisation rack in the duct:** made to fit the duct, with stainless steel components;
- **hygiene aspects:** for ambient humidification the pipes downstream of the pump allow both automatic and manual cleaning;
- **energy consumption:** just 4 W/(kg/h), equal to 1.5 kW for the 350 kg/h model;
- **optional:** infrared remote control.



## System composition

The complete **humiFog** system requires a water treatment device (e.g. reverse osmosis) and includes a pump assembly, connection pipes, atomisation nozzles, a rack for the nozzles in the case of ducted humidification, and one or two humidity probes.

### Atomisation

- The fog is readily absorbable because it is made up of very fine droplets (10 to 15 µm), generated by nozzles with an opening of just 0.2 mm that atomise water at high pressure (20 to 80 bars);
- clean, because **humiFog** uses demineralised water, dramatically reducing the amount of mineral dust released into the air;
- economical, because **humiFog** does not require an air compressor.

### Rack for humidification in the duct

- Designed to fit the duct and made from stainless steel components that withstand pressures of up to 100 bars;
- electrovalves intercept the various manifolds favouring a better modulation;
- absorption of the droplets by the air can be increased using the optional turbulators.

### Connection and distribution pipes

Special rubber hoses or stainless steel pipes are available that can operate at pressures up to 100 bars, as well as a series of fittings for the plumbing connections between the pump assembly and the rack and/or the distribution pipes in the room.

### Hygiene aspects

#### (**humiFog** for ambient humidification)

Both in the models with inverter (if operation at constant outlet pressure is enabled) and without inverter, the pipework downstream of the pump can be flushed. The flushing cycle has the following characteristics:

- **humiFog** washes the pipes downstream of the pump by draining water for a set time, depending on the actual length of the pipes;
- the **flush cycle** can be activated **manually** from the keypad, or alternatively performed **automatically**

### **humiFog** with/without inverter

- **Models with inverter:** these are the more sophisticated models, as they can be configured to humidify in the duct or to supply water at a constant pressure for ambient applications (in both cases, the flow-rate can vary from around 15% to 100% of the rated value of the pump, and the pressure between 20 and 80 bars):
  - **ducted humidification:** the water flow-rate is modulated by the inverter for very precise control of the set humidity (the minimum step of the flow-rate is equal about to 0.7 l/h in the 350 l/h model).
  - **operation at constant outlet pressure:** this mode is suitable for ambient or multi-zone humidification. When demand for water at the outlet changes, **humiFog** maintains the outlet pressure constant at the value set by the inverter: the user can operate with water at a constant pressure according to requirements, adjusting the flow-rate using an external electrovalve not controlled by **humiFog**.
- **Models without inverter:** this mode is suitable for ambient or multi-zone humidification without special requirements in terms of precision. The models without inverter provide water at a constant pressure (70 bars) that can be used as required, adjusting the flow-rate using an external electrovalve: the user may choose to have the electrovalve controlled by **humiFog** or by external humidistats/controllers. The flow-rate of water at the outlet may vary between 25% and 100% of the rated value of the pump.

by the controller whenever **humiFog** is restarted or following a period of inactivity, the duration of which can be set by the operator.

### Probes

An ambient probe or a humidistat is required for measuring the relative humidity and, in the case of ducted humidification, a limit probe should be installed downstream of the rack to avoid problems of condensation.



# humiFog

The wide range of models available makes humiFog the ideal solution for humidification in air handling units and “in room” applications, for large scale civil or industrial installations.

Typical applications include: supermarkets, offices, museums, libraries, printing industries, textiles or the processing of tobacco.

N.B.: 500 kg/h and 1350 lb/hr models will be available within the end of 2004.

	WITH inverter UA*H*	WITHOUT inverter UA*S*
USA: 208 Vac 50/60 Hz, single-phase	lb/hr 220 - 330 - 440 - 730 - 1000 - 1350	
EU: 230 Vac 50/60 Hz, single-phase	kg/h 60 - 120 - 180 - 250 - 350 - 500	
EU: 400 Vac 50 Hz, three-phase		kg/h 60 - 120 - 180 - 250 - 350 - 500

## Characteristics

- Adiabatic atomiser without compressed air;
- extremely low running costs for humidification “in room” and in ducts;
- racks to fit the duct;
- high efficiency nozzles that allow fine atomisation (10 to 15 µm);
- precise modulation of the atomisation in models with inverter.

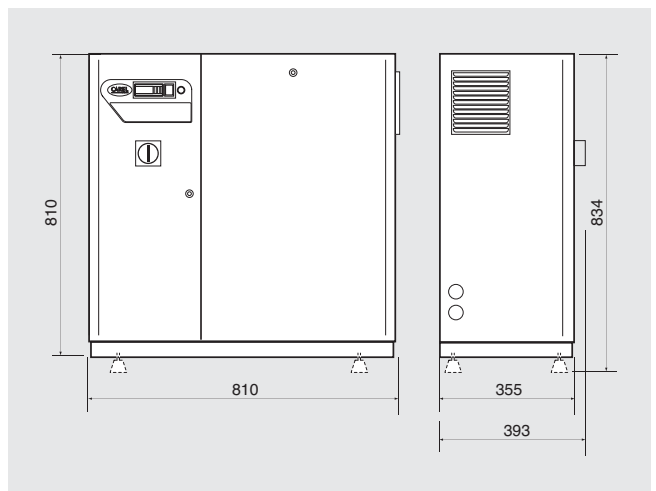

## Reverse osmosis

For correct operation, the humiFog system should be supplied with treated water.

The recommended limit values are listed on the following page. To reach these values, in normal circumstances, a reverse osmosis system is required for the treatment of mains water.

The principle that the operation of this system is based on involves sending the water through a special filter that is only permeable to molecules that are the same size as H<sub>2</sub>O. There are various reverse osmosis systems available, with outputs that range from a few litres to several m<sup>3</sup> of water per hour, and which can therefore be used to supply a series of humiFog appliances.

When the water used has been treated by reverse osmosis, the risks of blocking the nozzles and conveying dust into the environment are reduced significantly.

Normally, using tap water, which may contain up to 500 mg/l of dissolved salts, over a period of one year, up to 100 kg of small solid particles (dust measuring from 0.5 to 1 µm) are released into the environment. When atomising water treated by reverse osmosis (that contains 25 mg/l of dissolved salts), the dust introduced in one year is reduced to just 5 kg.



## Controllers

The control system integrated into the humiFog pump assembly can be set for all necessary operating conditions, by simply setting the parameters on the control interface.

The following types of control are possible:

- modulating control (UA\*H\*), or step (UA\*S\*) with input signal from an external humidity probe;
- modulating (UA\*H\*) or stepped control (UA\*S\*) with input signal from an external humidity probe and limit probe;
- modulating (UA\*H\*) or stepped control (UA\*S\*) with input signal from external controller;
- modulating (UA\*H\*) or stepped control (UA\*S\*) with input signal from external controller and limit probe;
- ON/OFF control (UA\*H\* and UA\*S\*) with input signal from external mechanical contact or humidistat.



## Pump assembly

In the standard version, the pump is made from brass. In some special applications, for example, in the food industry or when the conductivity of the water is below 20 to 30 µS/cm, it is recommended that the alternative Stainless Steel assembly is used.



## Pulsation damper

1309513AXX

The damper reduces the peaks in pressure generated by the pump pistons so as to limit vibration/resonance along the pipes and lengthens the pump life.



## Connection pipes

UAKT\*00000

Pipes are required for the connections between the pump assembly and the rack or the manifolds for humidification directly in the room. CAREL provides all the parts required to make these connections.

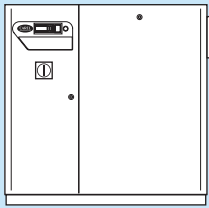

Model	UA*H*	UA*S*
Rated atomisation capacity	EU: 60, 120, 180, 250, 350, 500 kg/h USA: 220, 330, 440, 730, 1000, 1350 lb/hr	
Power supply	EU: 230 Vac single-phase, 50/60 Hz USA: 208 Vac single-phase, 50/60 Hz	EU: 400 Vac three-phase, 50 Hz
Power consumption	0.4 - 0.6 - 0.8 - 1.2 - 1.5 - 2.5 kW	
Operating conditions	1T40 °C, 20 to 80% rH non-cond.	
Storage conditions	1T50 °C, 0 to 80% rH non-cond.	
Index of protection	IP20	

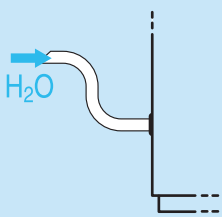

Fitting	Ø 8/10 mm - 1/2" G female
Temperature limits	1T50 °C
Water pressure limits	0.2 to 0.4 MPa / 2 to 4 bar
Instant flow-rate	1 - 2 - 3 - 4.2 - 5.8 - 8.4 l/min
Total hardness	0 to 25 ppm CaCO <sub>3</sub>
Conductivity limits	0 to 50 µS/cm

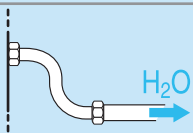

Fitting	Ø 1/4" G female
Water pressure	2 to 8 MPa / 20 to 80 bar

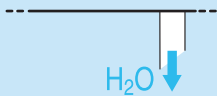

Fitting	Ø 10 mm
Temperature	63 °C



Type	UAH* (modulating)	UAS* (stepped)
Input	0 to 10 V, 0 to 1 V, 2 to 10 V; 0 to 20 mA; 4 to 20 mA	
- selectable signal	voltage 60 kΩ, current 50 Ω	
- input impedance	12 Vdc stabilised max. 50 mA	
- power supply to active probes	32 Vac (24 Vac rectified) max. 250 mA	

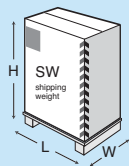

Unit (LxWxH)	930x390x860 mm
Packaging (LxWxH)	1000x480x1000 mm
Weight of packaged product (SW)	82, 84, 86, 90, 93, 103 kg

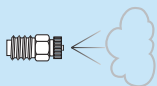

Material	stainless steel
Capacity of the nozzles at 70 bar	MTP1 = 2.7 kg/h - MTP2 = 3.6 kg/h
Turbochargers (optional)	152x152x60 mm



Network connection	RS485; Modbus® (with opt. Gateway); BACnet™ (with opt. Gateway)
--------------------	---



## OVERVIEW DRAWING humiFog with inverter UA\*H\* ducted and multi-zone humidification

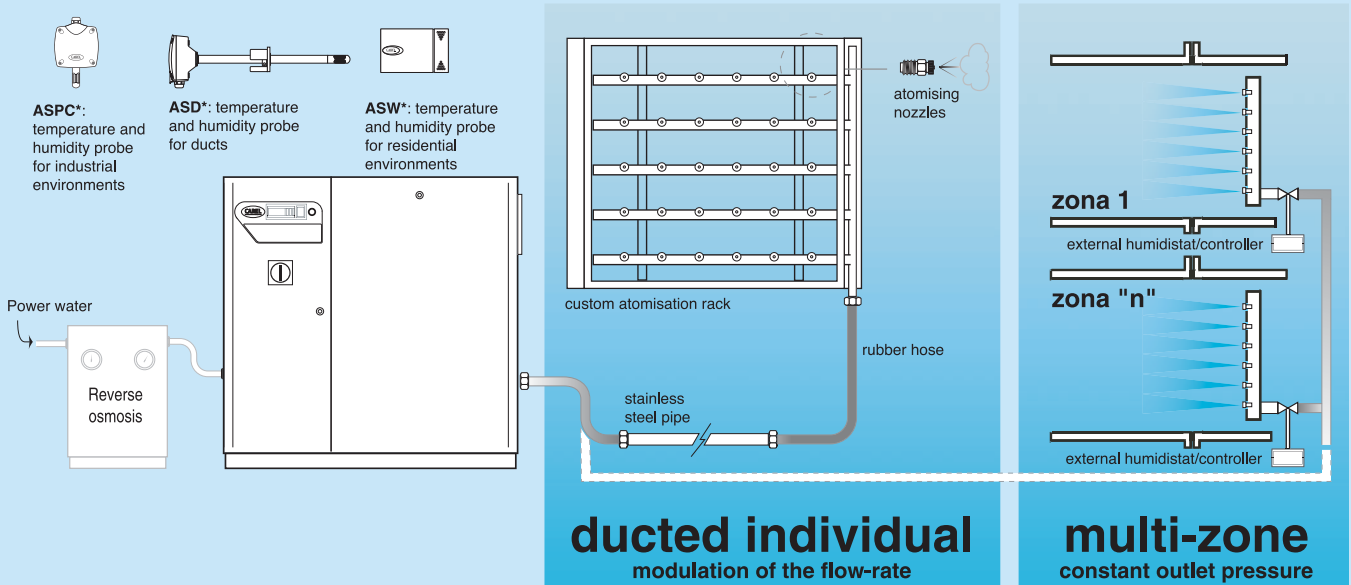

## OVERVIEW DRAWING of the humiFog without inverter UA\*S\* ambient and multi-zone humidification

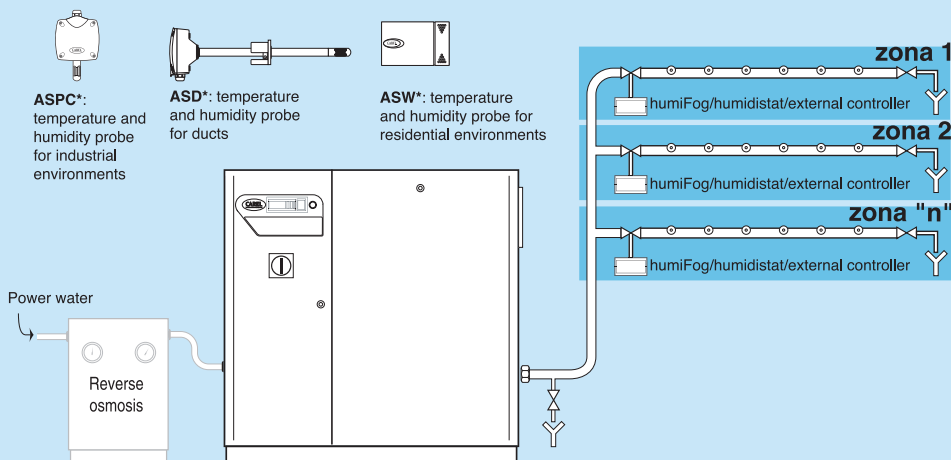

### humiFog with inverter

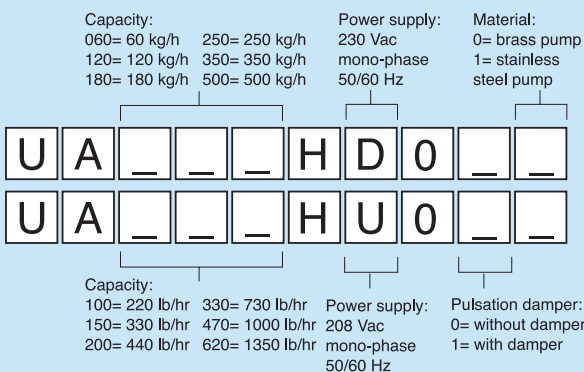

### humiFog without inverter

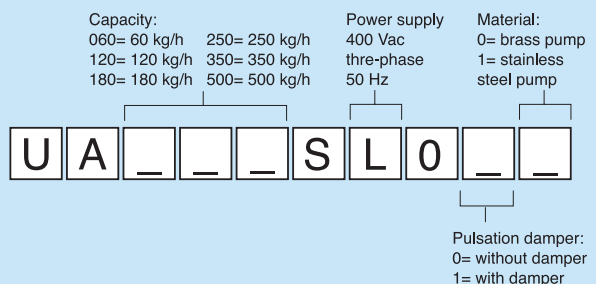



## Valve kit for pump

UAKVP00000

The valve kit for the pump pistons includes the valves and the gaskets for the three pistons.

The valves should be replaced approximately every 4,000 operating hours.



## Pump gasket kit

UAKGP00000

The kit contains a set of rubber gaskets.

To avoid water leaks, the pump gaskets should be replaced approximately every 4,000 operating hours.

Each kit contains all the items required to replace the gaskets on the pump pistons.



## Filter kit

UAKFW00000

The two filters used to remove any impurities from the water, located in the pump assembly, should be replaced if there is a pressure drop between the filters of more than 0.5 bars.

The kit includes:

- 1x5 µm water filter, height 9";
- 1x1 µm water filter, height 9".



## Oil for the pump

5024645AXX

Special oil is available for the pump.

A 1 litre tank is sufficient for a complete oil change.



## humivisor: remote terminal with graphic display

URT0000000

The humivisor remote terminal with graphic display (URT0000000) is used to manage a local network made up of a maximum of 4 humidifiers from the humiSteam, heaterSteam, gaSteam or humiFog series. The network connection is made from a RS485 serial line with a two-wire cable in a daisy-chain configuration. This terminal can display and set, in a centralised manner, the status and the parameters for each humidifier, making the supervision and the control of the network simple and fast. The display is backlit and the contrast can be adjusted so as to make the display clearly visible in all conditions. The terminal is fitted with a clock that is used to set the weekly ON/OFF cycles for all the humidifiers in network.



## Remote control

TELUA0\*000

A remote control is available to simplify the programming of most of the modulating control humidifiers from a distance: heaterSteam, humiSteam, gaSteam and humiFog.

The remote control is available in the italian or english versions.



## Standard racks

Racks are available in standard sizes, based on the dimensions of the duct and the capacity of the humiFog used.



## Drop separator

CAREL can offer a drop separator properly designed for humiFog and built according to the duct. The separator is supplied in modular panels that can be easily assembled. The pressure drop is very low and, with air at 2.5 m/s, varies from 30 Pa with dry filter to 50 Pa with wet filter.



## Junction box

UAKDER\*0000

Junction box for the electrovalves fitted on the atomising rack in the duct.

Used when there are from 4 to 8 electrovalves.



## Compressed air and water atomisers

The principle of the **mc** system involves sending a mixture of water and compressed air through atomising nozzles to create a fine fog made up of very small droplets. The atomised water is easily absorbed by the air and, as a side effect to the humidification process, the air temperature decreases: therefore, the **mc** system can also be used to cool the air. **mc** systems are fitted with an exclusive self-cleaning system that drains the water from the pipes and cleans the nozzles with compressed air when the system is deactivated; the opening of the nozzles is then closed by a needle to prevent dripping. The self-cleaning system, as well as ensuring hygienic operation, also minimises the need for maintenance.

### Advantages

- **Versatility:** **mc** is suitable for humidification directly into the room and in ducts;
- **adiabatic humidifier:** humidifies and cools the air (cooling effect of up to 10 °C);
- **atomisation:** the fog is readily absorbed, being made up of very fine droplets (around 10 µm);
- **modulation of the water flow-rate:** ON/OFF or proportional;
- **supply water:** mains or demineralised (the use of demineralised water reduces the mineral dust introduced into the air and the maintenance of the nozzles);
- **hygiene advantages:** automatic periodical self-cleaning cycle on each nozzle;
- **energy consumption:** around 100 W/(kg/h), including the external compressor.



## System composition

The basic **mc** system is made up of a cabinet, manifolds, atomising nozzles, filters for the removal of any impurities in the air and water and, in the case of ducted humidification, two humidity probes.

The **mc** system is designed for both ambient and duct installations. In the former, the atomised water is distributed directly into the room, and a room probe is used as the reference for the humidification requirement. In ducted installations, the **mc** nozzles are installed directly in the duct; as well as the reference probe, a limit probe should also be installed downstream to prevent unwanted condensation.

### Cabinet

The **mc** cabinet is supplied with compressed air at 5 to 10 bars and water at 2 to 4 bars. The 2 to 4 bar water pressure is usually possible by direct connection between the mains and the cabinet. For the compression of the air, on the other hand, a compressor is required (not supplied by CAREL).

The cabinet is available for mains water and demineralised water. All parts of the water line, fitted in the **mc** cabinet for demineralised water, are made from stainless steel and corrosion resistant plastic.

This product is therefore recommended for treated water, with conductivity less than 20 to 30  $\mu\text{S}/\text{cm}$ .

### Nozzles

CAREL provides the special **mc** nozzles available for five different flow-rates that mix the compressed air and water, and an assembly kit for the installation of each nozzle.

The **mc** nozzles atomise the water to create an extremely fine mist of minute droplets, with an average diameter of 10  $\mu\text{m}$ , which are easily absorbed by the surrounding air.

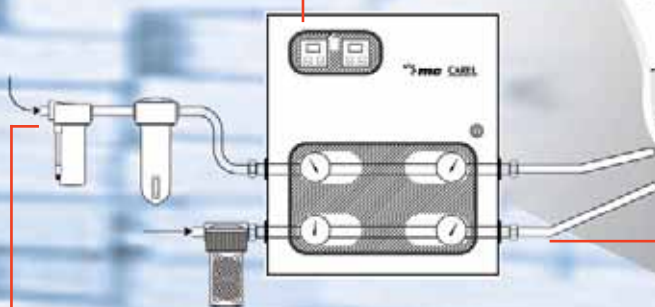

### Filters

For optimum operation, CAREL proposes a water filter and a filtering cartridge installed directly in the water line.

For the compressed air line, CAREL provides a filter to prevent solid particles from reducing or blocking the flow to the nozzles. In addition, an oil filter is available to remove any oil from the compressed air.

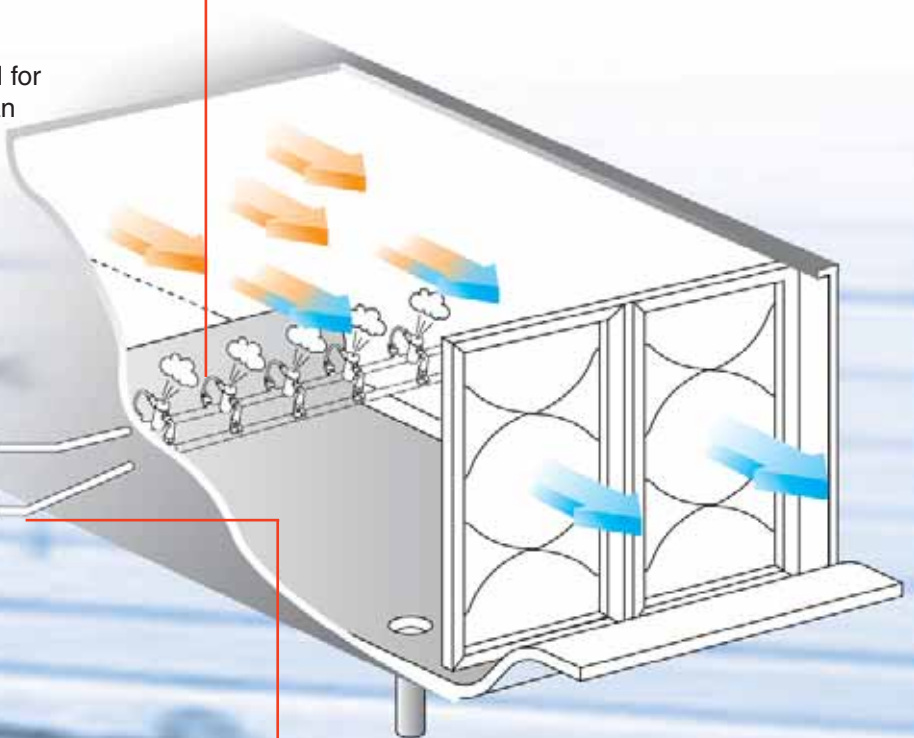

### Manifolds

Upon request, CAREL can also provide the manifolds for ducted installations (the manifolds for installations in the room are not supplied by CAREL).



## mc

The mc system, available with proportional or ON/OFF control, can be used with demineralised water or mains water, in either room or ducts.

Some of the typical applications of the mc system include large production areas, cold rooms for storing fruit and vegetables, timber and paper depots, printing facilities and glasshouses.

### Characteristics

- Ideal for humidification directly in the room and in ducts;
- extremely low running costs (100 W per l/h of atomised water);
- reduced maintenance thanks to the self-cleaning cycle;
- high efficiency nozzles that allow fine atomisation (10 to 15 µm);
- modulation of atomisation from 50% to 100%.

Capacity	Installation	Regulation	Type of water	
			Mains water	Demineralized water
60 kg/h	Ambient	ON/OFF	MCRDNW0001	MCRDAW1001
		proportional	MCRPNW0001	MCRPAW1001
	Duct	ON/OFF	—	—
		proportional	MCDPNW0001	MCDPAW1001
230 kg/h	Ambient	ON/OFF	MCRDNW0000	MCRDAW1000
		proportional	MCRPNW0000	MCRPAW1000
	Duct	ON/OFF	—	—
		proportional	MCDPNW0000	MCDPAW1000

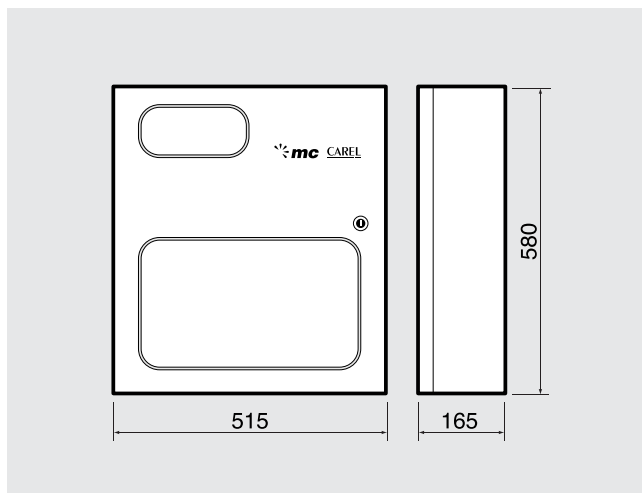



## Controllers

CR7214\*

The mc cabinets feature a control unit available in ON/OFF or modulating proportional version. In the systems with ON/OFF control, maximum air pressure (around 2.1 bars) is always supplied to the nozzle when the cabinet is active and therefore the production of humidity is always at 0% or 100%. With proportional control, the humidification capacity can be modulated from 50% to 100%, allowing accurate control of the humidity level and making the system ideal for applications in which a precise level of humidity is required.



## Nozzles and assembly kit

MCA\* and MCK1AW0000

The nozzles, machined from AISI316 stainless steel, are available for five different flow-rates, but all with the same external dimensions.

The automatic mechanical nozzle self-cleaning system prevents the depositing of lime scale and other impurities. Dripping is avoided thanks to the closing mechanism in periods of inactivity. The nozzle assembly kit includes the components required for assembly of a nozzle between a manifold in the water line and a manifold in the compressed air line, and is suitable for all types of MC nozzles.



## Air/water lines

98C150P013 - 14 - 17 - 18 (air lines)

98C150P015 - 16 - 19 - 20 (water lines)

Spare air and water lines are available for the cabinets, including filters, pressure gauges to control the pressure of the compressed air or water, and valves.



## Water filters

MCFILWAT05 and MCC05PP005 (cartridge filter)

The water filter is made from propylene and is used to remove particles up to 5 µm. The filter should be replaced approximately every 6,000 operating hours to avoid the accumulation of germs or an excessive pressure drop due to the accumulation of impurities. The water filter is supplied without the plastic cartridge needed for its operation. The water filter cartridge is made from plastic and should be fitted in the water supply line before the cabinet. The filter only works when the cartridge is inserted.



## Solid particle filters for compressed air

MCFILAIR01

The solid particle filter is used to eliminate solid particles and impurities up to 5 µm from the compressed air. It is always recommended that the air filter is used so as to prevent the impurities from reducing or blocking the flow through the nozzles. This filter should be installed in the air-line after the compressor and before the cabinet.



## Oil filter for compressed air

MCFILOIL01

The oil filter is used to eliminate any oil from the compressed air, so as to ensure the correct operation of the atomising nozzles.

The oil filter also contains an air filter and consequently must be installed in the air-line after the solid particle filter.

# Adiabatic humidifiers/compressed air and water atomisers/mc

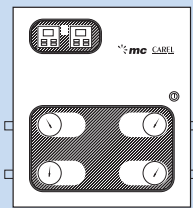

Model	MC060*	MC230*
Maximum humidification capacity	60 kg/h	230 kg/h
Power supply	230 Vac, 50/60Hz, single-phase	
Operating conditions	1T50 °C, 20 to 90 rH non-cond.	
Storage conditions	-10T70 °C, 0 to 90 rH non-cond.	
Index of protection	IP55	

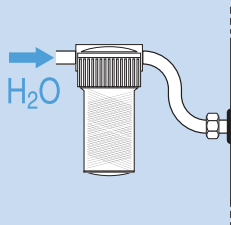

Fitting	Ø 1/4"G female	Ø 1/2"G female
Temperature limits	1T50 °C	
Water pressure limits	0.2 to 0.4 MPa / 2 to 4 bar	
Instant flow-rate	1 l/min	3.8 l/min
Total hardness*	0 to 400 ppm CaCO <sub>3</sub>	
Conductivity limits*	0 to 1250 µS/cm	

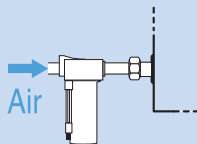

Fitting	Ø 1/4"G female	Ø 1/2"G female
Air pressure	0.5 to 1.0 MPa / 5 to 10 bar	

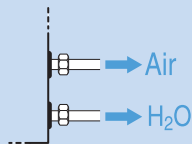

Fitting	Ø 1/4"G female	Ø 1/2"G female
Water pressure	0.035 MPa + 0.01 x Δh / 0.35 bar + 0.1 x Δh <small>(Δh: difference in height in metres between the cabinet and the nozzles)</small>	

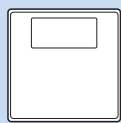

Type	CR7214* (proportional)
Power supply for active probes	8 to 24 Vac max. 40 mA
Probe input signals	- selectable signals
	-1 to 1 V and 0 to 10 V

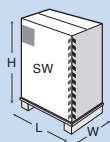

Unit (LxWxH)	515x165x580 mm
Packaging (LxWxH)	220x600x640 mm
Weight of packaged product (SW)	23, 24, 25, 26 kg

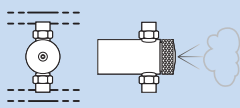

Material	stainless steel (AISI 316)
Capacity of the nozzles at 2.1 bars	2.7 - 4.0 - 5.4 - 6.8 - 10 kg/h
Max compressed air consumption	3.4 - 5.1 - 6.7 - 8.6 - 12.7 m <sup>3</sup> /h



Dimensions	Ø 62 mm, h: 180 mm, weight: 0.4 kg
Fittings (inlet/outlet)	1/2"G female
Filtering	5 µm



Dimensions	Ø 85 mm, h: 267 mm, weight: 1.1 kg
Fittings (inlet/outlet)	3/8"G female
Filtering	1 µm

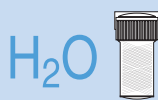

Dimensions	Ø 50 mm, h: 175 mm, weight: 0.4 kg
Fittings (inlet/outlet)	1/2"G female
Filtering	5 µm



Network connection	RS422; Modbus® (with opt. Gateway); BACnet™ (with opt. Gateway)
--------------------	---



# OVERVIEW DRAWING

## duct and ambient applications

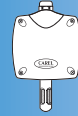
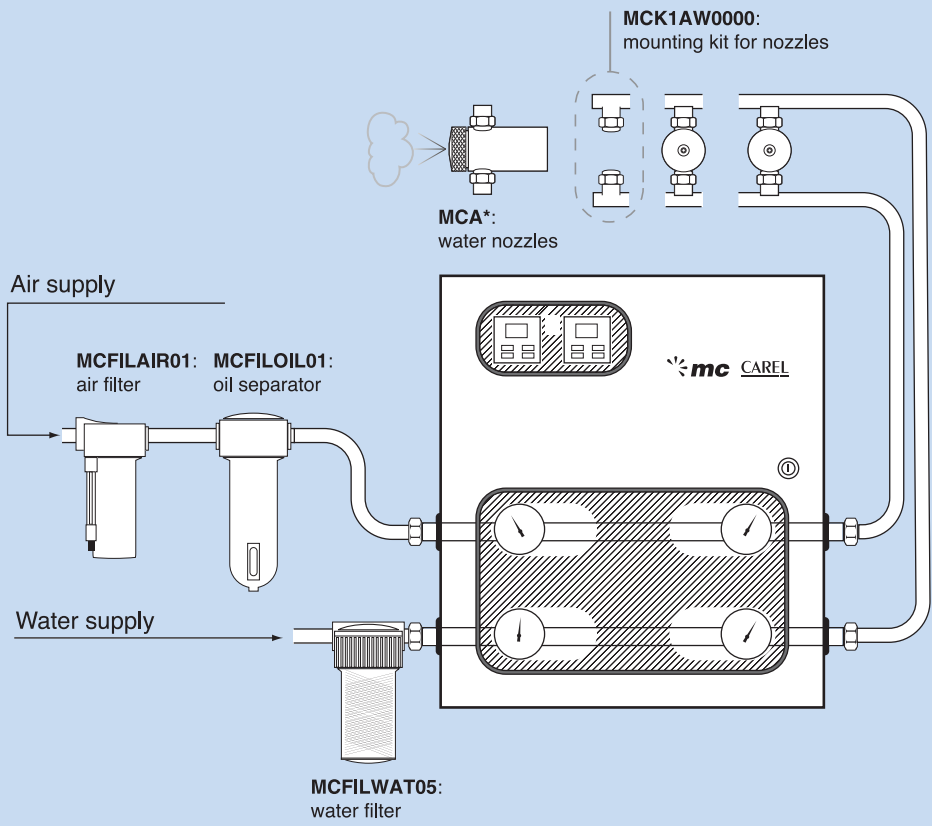

**ASPC\***: precision ambient temperature and humidity probe

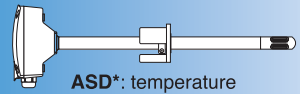

**ASD\***: temperature and humidity duct probe



**ASW\***: ambient temperature and humidity probe

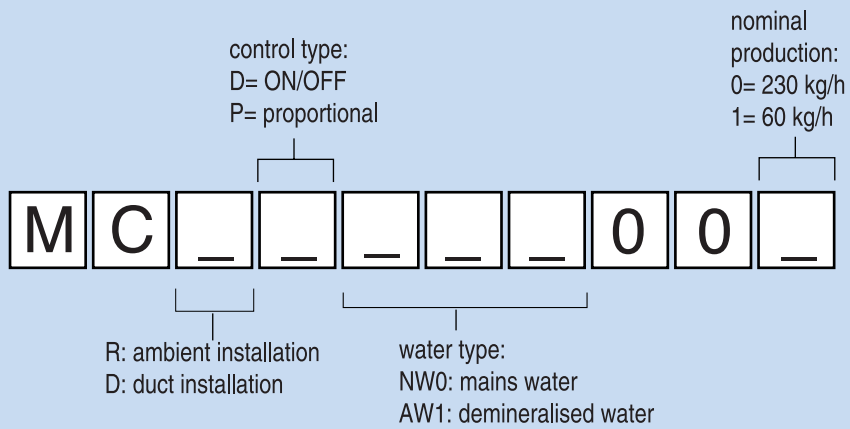

**Note:** that not all combinations of characters are available. Please contact CAREL dealer for further information.



## Centrifugal humidifiers

*humiDisk* is a small adiabatic humidifier that, thanks to its centrifugal effect, atomises water into a very fine fog that is easily absorbed by the air.

This is a simple, economic and easy to maintain humidification system. With an energy consumption of just 100 W for each litre of atomised water per hour, the operating costs of the *humiDisk* are much lower than those of isothermal steam humidifiers.

Each *humiDisk* centrifugal humidifier must be connected to an electrical control panel (HDE05 or HDE10, for the control of one or two *humiDisk* units).

The electrical panel manages all the functions of the humidifier: power supply and control of the motor, electric heater, fill valve, drain valve, float and alarm outputs.

### Advantages

- **Typical applications:** adiabatic ambient humidification (cold rooms, textile industries, etc.). The presence of the built-in temperature controlled heater allows operation at temperatures down to  $-2\text{ }^{\circ}\text{C}$ ;
- **adiabatic humidifier:** humidifies and cools the air;
- **simplicity:** installable on the wall, floor or hung from the ceiling, only requires the 230 Vac power supply and the mains water line with ON/OFF modulation (the direction of atomisation can be adjusted by turning the *humiDisk* dome). The humidistat is contained in the control panel;
- **modularity:** 1 or 2 *humiDisk* appliances can be controlled in parallel by the special control panel;
- **hygiene advantages:** the water tank is automatically drained at the end of the humidification cycle;
- **energy consumption:** around  $100\text{ W}/(\text{kg}/\text{h})$ ;
- **optional:** infrared remote control.



## humiDisk

humiDisk can be installed directly on the floor, but is also fitted for wall-mounting. The operating principle of humiDisk is very simple: a spinning disk creates very fine droplets of water that are sprayed into the environment by a fan that, through the adjustable outlet, allows distribution in any direction.

Thanks to its cooling effect (built-in heater), its compactness and its simplicity, humiDisk is suitable for various small applications.

Some example applications:

- cold rooms and stores for fruit and vegetables,
- maturing rooms,
- printing facilities,
- textile industries.

### Characteristics

- Easy to install and use;
- fitted for assembly on the floor, ceiling and wall (supplied with brackets for installation);
- adjustable outlets;
- built-in heater for operation just below 0 °C (min. -2 °C);
- automatic cleaning cycle activated when the unit is on in standby to avoid the formation of bacteria;
- ability to connect two humidifiers in parallel.

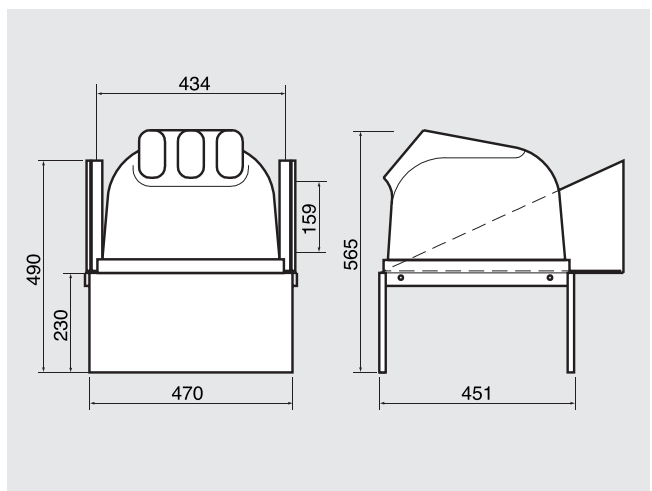

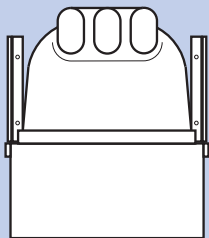

**Model**

**HDU05\* and HDU06\***

Atomised water flow-rate	HDU05*: 5 kg/h (mechanically adjustable in 3 steps: 1.5 – 3 – 5 kg/h) HDU06*: 6.5 kg/h (variable from 1.1 a 6.5 kg/h)
Power supply	230 Vac single-phase 50 or 60 Hz (according to the model)
Operating conditions	-2T30 °C, 0 to 90 rH non-cond.
Storage conditions	-10T60 °C, 0 to 90 rH non-cond.
Power	500 W
Current	3 A
Index of protection	IP14

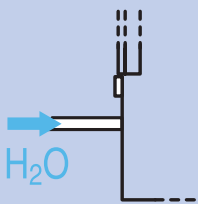

Fitting	3/4" G male
Temperature limits	1T50 °C
Water pressure limits	3 MPa/ 30 bar
Instant flow-rate	0 to 40 l/min
Total hardness	150 to 400 ppm CaCO <sub>3</sub>
Conductivity limits	100 to 1250 µS/cm
Tank capacity	HDU05*: 2 l - HDU06*: 0.06 l

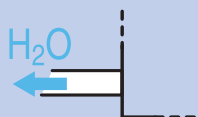

Water drain	Ø 10 mm
Overflow	Ø 10 mm

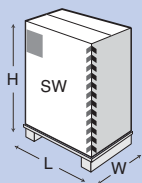

Unit (LxWxH)	470x451x565 mm
Weight (vuoto)	18 kg (hung) / 21 kg (wall-mounting)
Packaging (LxWxH)	500x500x600 mm
Weight of packaged product (SW)	21 kg

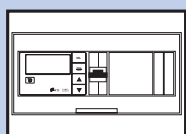

**Model**

**HDE\*MP230**

Power supply	230 Vac (-15% to +10%), 50/60 Hz, single-phase
Operating conditions	0T50 °C, 0 to 90 rH no cond.
Storage conditions	-10T70 °C, 0 to 90 rH no cond.
Index of protection	IP55

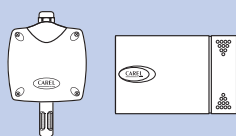

Power supply to active probes	10 Vdc; max. 30 mA
Signal input probes	
- selectable input signals	-0.4 to 1 Vdc
Active humidity probes	ASPC*, ASW*

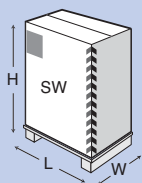

Electrical panel (LxWxH)	288x200x130 mm
Weight	1.75 kg
Packaging (LxWxH)	366x285x185 mm
Weight of packaged panel (SW)	2.29 kg



# OVERVIEW DRAWING

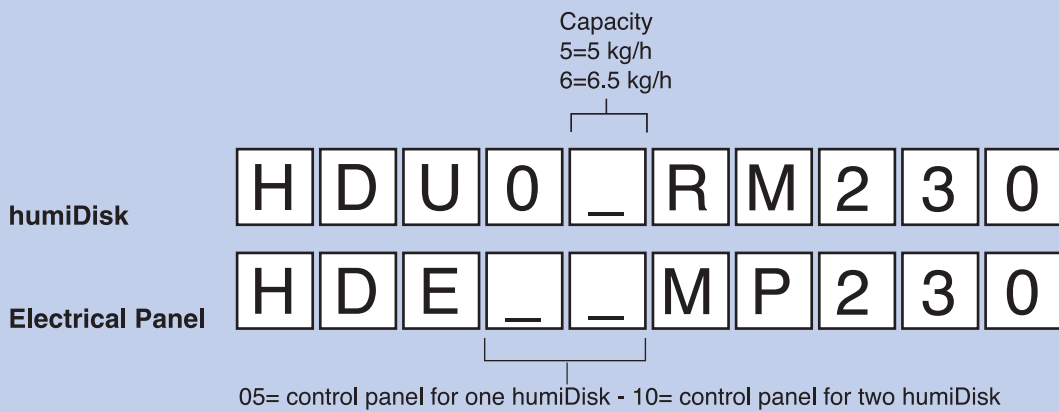
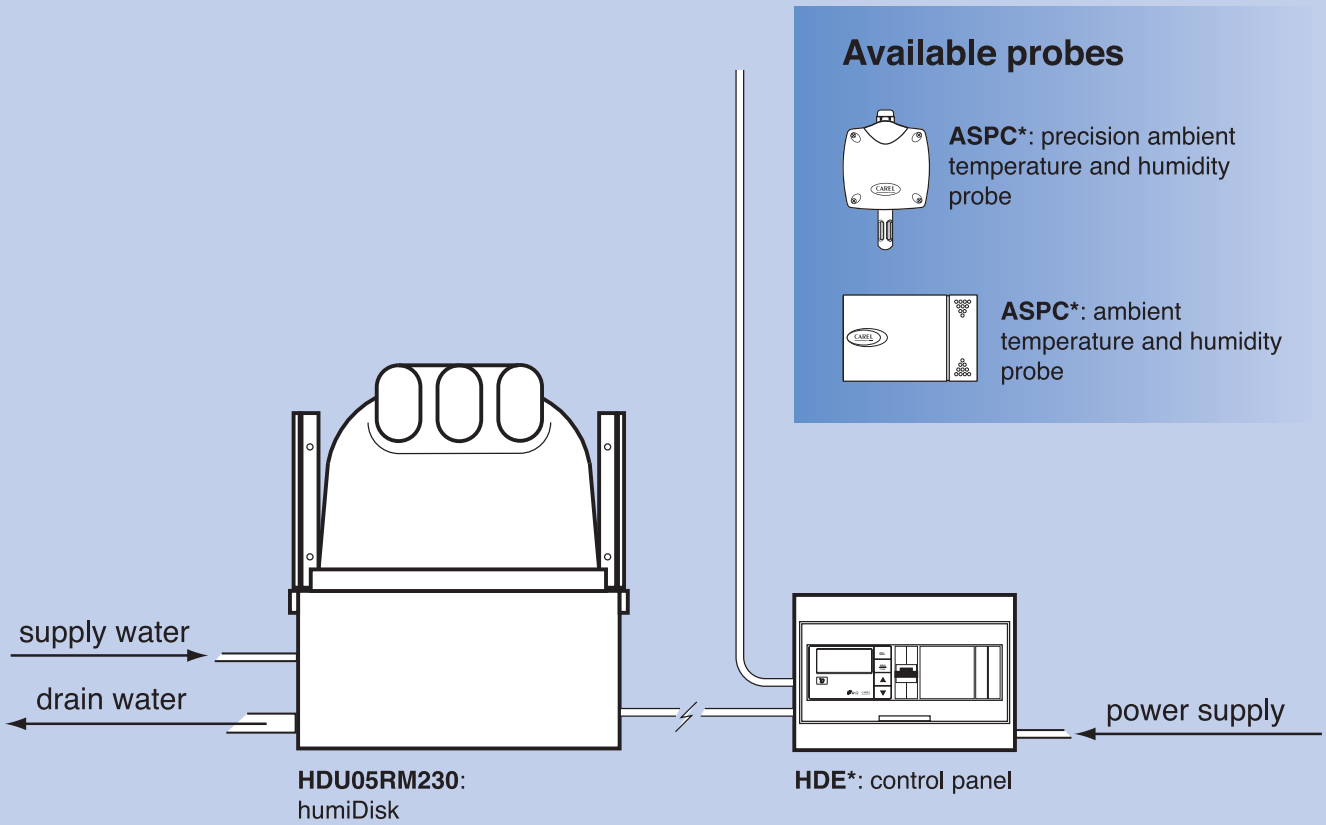



# **Probes and control devices**

---



## Probes

CAREL offers increasingly advanced and complete global solutions.

For this reason, CAREL has designed an entire range of probes that respond to the needs of HVAC/R installers and manufacturers, as well as for the control of CAREL's own line of humidifiers.

The range includes temperature and humidity sensors for various applications, with installation in sockets or ducts, in residential or industrial environments, guaranteeing high performance and compatibility with all CAREL controllers.

The range has been enriched with the most innovative technological solutions, offering new international standards at increasingly competitive prices.

## Advantages

CAREL probes, as well as featuring the recognised performance that sets them apart, are very versatile and can satisfy various market requirements.

Indeed, all the probes have been especially designed to be compatible not only with all CAREL controllers, but also with the most commonly used standards around the world.

The temperature and humidity probes are available with different operating ranges and in special versions for corrosive or polluting environments.

The high quality probes are available for ambient installation, duct installation and for industrial applications where special conditions may occur. It is recommended to consider all relevant parameters such as probe protection index, the operating air conditions, the power supply and range of the output signal.





## Active temperature, humidity and temperature/humidity probes

**ASW\***: for room installation

Particularly suitable for residential and commercial environments with precise design requirements.

**ASD\***: for duct installation

Used in ducted heating and air-conditioning systems.

Type: active temperature, humidity and temperature/humidity probes  
 Power supply: 12/24 Vac (-10% to +15%), 9 to 30 Vdc ( $\pm 10\%$ )  
 Operating conditions: **ASD\***: -10T70 °C, <100% rH non-cond.;  
**ASW\***: -10T70 °C or 0T50 °C, <100% rH non-cond.  
 Storage conditions: -20T70 °C, <90% rH non-cond.  
 Connections: screw terminal blocks for cables up to 1.5 mm<sup>2</sup>  
 Installation: **ASW\***: wall mounting - **ASD\***: in ducts with mobile flange  
 Index of protection: **ASW\***: IP30 - **ASD\***: IP55 (case); IP40 (sensor)

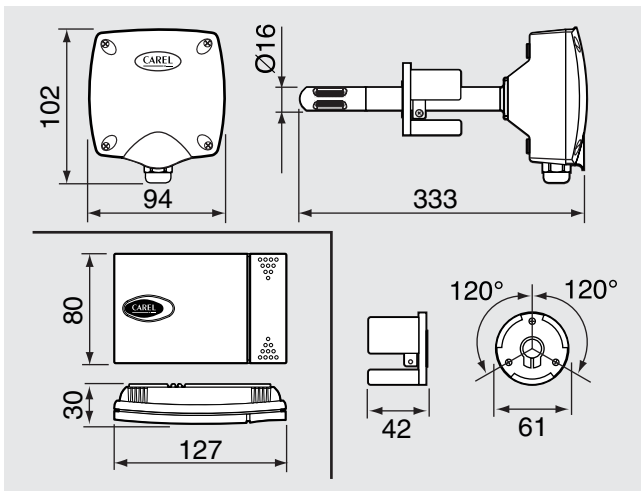

## Active temperature/humidity probes

**ASP\***: for industrial environments

Specifically designed to measure high humidity levels with great precision.

Type: active temperature, humidity and temperature/humidity probes  
 Power supply: 12/24 Vac (-10% to +15%), 9 to 30 Vdc ( $\pm 10\%$ )  
 Operating conditions: -10T70 °C, <100% rH non-cond.  
 Storage conditions: -20T70 °C, <100% rH non-cond.  
 Connections: screw terminal blocks for cables up to 1.5 mm<sup>2</sup>  
 Installation: wall mounting  
 Index of protection: IP55 (case) and IP54 (sensor)

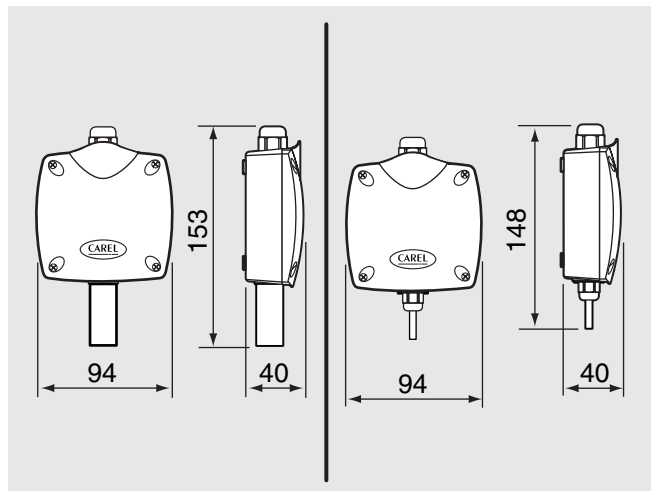



## Universal temperature probes

### ASET\*

These probes can be used in a multitude of applications. The version ASET03\* features an electronic amplifier, protected by an IP55 plastic enclosure, which allows remote installation at up to 100 m with a current output signal.

Type: universal temperature probes

Power supply: 12/24 Vac (-10% to +15%), 9 to 30 Vdc ( $\pm 10\%$ )

Operating conditions: -10T60 °C, <100% rH non-cond.

Storage conditions: -20T70 °C, <100% rH non-cond.

Connections: screw terminal blocks for cables up to 1.5 mm<sup>2</sup>

Installation: direct or in socket

Index of protection: IP55 (case); IP67 (sensor)

Model	ASWH1*
Power supply	
– 9 to 30 Vdc; 12 to 24 Vdc	●
– 24 Vac/dc	
Power input	–
Probe dimensions (mm)	127x30x80
Operating conditions	
– -10T70 °C, 10 to 90% rH non-cond.	●
– 0T50 °C, 10. to 90% rH non-cond.	
– -10T70 °C, <90% rH non-cond.	
– -10T70 °C, 0 to 100% rH non-cond.	
Range	
– temperature: -30T50 °C	
– temperature: 0T50 °C	
– temperature: -10T70 °C	
– temperature: -30T90 °C or -30T150 °C	
– humidity: 10 to 90% rH	●
– humidity: 0 to 100% rH	
– diff. pressure: 0 to 32 mbar	
Precision	
– temperature: $\pm 1$ °C	
– temperature: 25 °C: $\pm 0,5\%$ , -30T90 °C: $\pm 1\%$	
– temperature: 25 °C: $\pm 0,5\%$ , -30T150 °C: $\pm 1.7\%$	
– humidity: 25 °C: $\pm 3\%$ , 0T50 °C: $\pm 6\%$	●
– humidity: 25 °C: $\pm 3\%$ , -10T70 °C: $\pm 5\%$	
– humidity: $\pm 5\%$ rH	
– diff. pressure: -10T50 °C and 0.1 to 32 mbar: $\pm 2\%$	
Output signals	–
Time constants	
– 60 s (still air), 20 s (3 m/s)	●
– 15 s (still air), 10 s (3 m/s)	
– 20 s (still air), 15 s (3 m/s)	
– temperature: 200 s (still air), 45 s (water)	
– humidity: <1 s, diff. pressure: 0.3 s	
Index of protection	
– case	IP30
– sensor	IP30

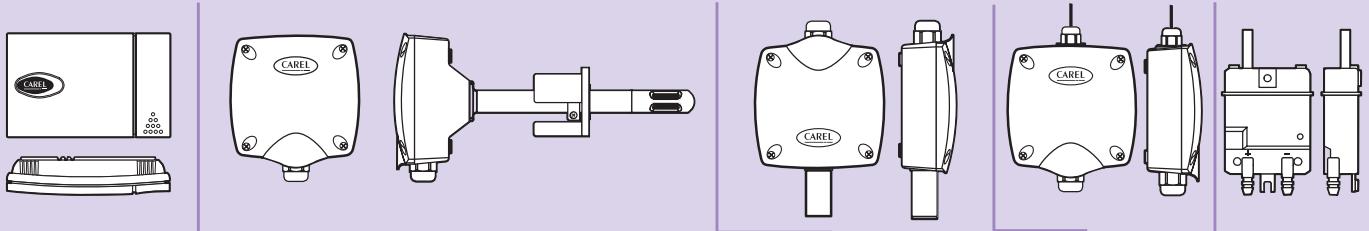

ASWC11*	ASWC111*	ASWC112*	ASDH1*	ASDH2*	ASDC111*	ASDC23*	ASPC11*	ASPC23*	ASET03*	ASDM244*
•	•	•	•	•	•	•	•	•	•	•
-	-	-	-	-	-	-	-	-	-	1.2 W
127x30x80			94x333x102				94x40x153 / 94x40x148		94x40x124	60x28x89
•	•	•	•	•	•	•	•	•	•	•
•	•	•	•	•	•	•	•	•	•	•
•	•	•	•	•	•	•	•	•	•	•
•	•	•	•	•	•	•	•	•	•	•
•	•	•	•	•	•	•	•	•	•	•
•	•	•	•	•	•	•	•	•	•	•
•	•	•	•	•	•	•	•	•	•	•
•	•	•	•	•	•	•	•	•	•	•
-	-	-	-	-	-	-	-	-	-0.3 to 1 V 4 to 20 mA	MP-Bus
•	•	•	•	•	•	•	•	•	•	•
•	•	•	•	•	•	•	•	•	•	•
IP30	IP30	IP30	IP55	IP55	IP55	IP55	IP55	IP55	IP55	IP54
IP30	IP30	IP30	IP40	IP40	IP40	IP40	IP54	IP54	IP67	



## Control device

CAREL is able to offer a wide range of control units.

The Carel humidistats from the universal infrared series features the IR32 humidistats for panel mounting and the IRDR humidistats for DIN mounting.

The programming of these versatile electronic humidistats is straight forward. Each unit features 9 pre-programmed operating modes and it is possible to configure a specific parameter (set point).

These universal humidistats exist with 1, 2 and 4 outputs and are prepared for infrared communication via a remote control (except the economical version IR32V\*E\*).

The humidistats are also prepared for a network connection with a serial card (except IR32V\*H).

### Advantages

- Extremely contained dimensions;
- possible connection to a remote terminal;
- great reliability;
- electronic expansion valve management;
- high efficiency icon ergonomic display;
- simple wiring (new tLAN serial network);
- modular architecture.



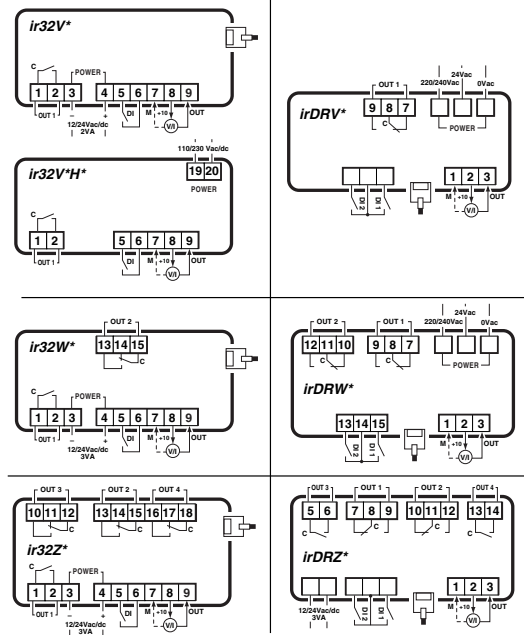

## IR32V - IR32W - IR32Z: universal humidistats and pressure switches with 1, 2 or 4 outputs

IR32V\*, IR32W\*, IR32Z\*  
and IRDRV\*, IRDRW\*, IRDRZ\*

These ir Universal series controllers can be connected to any transducer able to supply a current (0 to 20 mA or 4 to 20 mA) or voltage signal (0 to 1 Vdc) for the measurement and control of physical values such as the pressure, humidity, etc. The models with voltage inputs, using the additional CONVO/1000 module, can also accept transducers with a 0 to 10 Vdc output signal. They feature one digital input (two in the DIN rail version) that can be configured to manage functions such as an immediate or delayed external alarm, remote ON/OFF. The models with 4

outputs (IR32Z\*, IRDRZ\*) allow the rotation of the actuators, an especially useful function for compressor management.

Power supply: **IR32V\*E** and **IR32V\*L**: 12/24 Vac/dc ( $\pm 10\%$ ), 50/60 Hz  
**IR32V\*H**: 110/230 Vac/dc ( $\pm 10\%$ ), 50/60 Hz,  
**IR32W\***, **IR32Z\*** and **IRDRZ\***: 12/24 Vac/dc ( $\pm 10\%$ ), 50/60 Hz  
**IRDRV\*** and **IRDRW\***: 24 Vac ( $\pm 10\%$ ), 230 Vac ( $\pm 15\%$ ) 50/60 Hz  
 Operating conditions: 0T50 °C, <90% rH non-cond.  
 Storage conditions: -10T70 °C, <90% rH non-cond.  
 Input: **IR32\*3\*** and **IRDR\*3\***: 0 to 20 or 4 to 20 mA;  
**IR32\*4\*** and **IRDR\*4\***: -0.5 to 1 Vdc  
 Outputs: **IR32V\*** and **IRDRV\***: 1 relay 250 Vac 8 A res. ;  
**IR32W\*** and **IRDRW\***: 2 relays 250 Vac 8 A res. ;  
**IR32Z\*** **IRDRZ\***: 4 relays 250 Vac 8 A res.  
 Display: 3 digits with decimal point and sign  
 Precision:  $\pm 1\%$  on the set limits  
 Installation: **IR32\***: panel mounting; **IRDR\***: DIN rail mounting  
 Index of protection: **IR32\***: IP65, **IRDR\***: IP40

Panel  
mounting

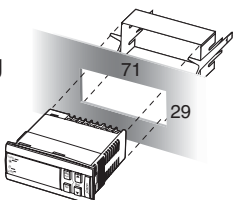

DIN-rail  
mounting

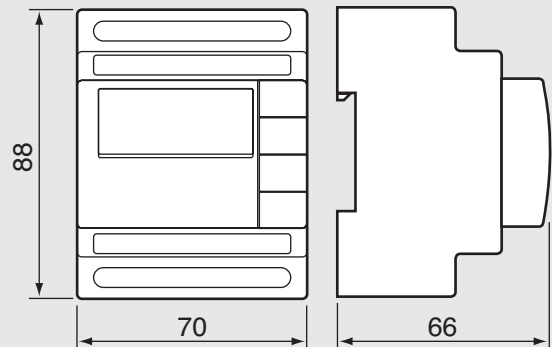
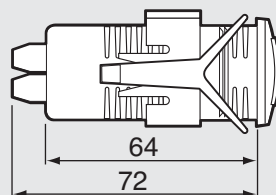
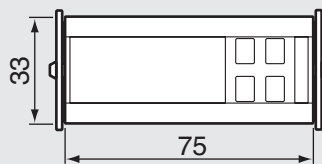
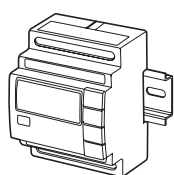



## Remote controller

TELU\*

A remote control is available for easy remote programming for most of the humidifiers with modulating control.

The remote controls available are indicated in the matrix below with the order number. The \* is to be substituted with E for the English version and I for the Italian version.

REMOTE CONTROLLER			
	ON/OFF C	Proportional P	Modulating H+T
homeSteam	NA	-	-
humiSteam	-	NA	TELUE0*000
heaterSteam	NA	-	TELUR0*000
gaSteam	-	-	TELUG0*000
humiFog	-	-	TELUA0*000
mc	NA	NA	-
humiDisk	IRTRRU*000	-	-

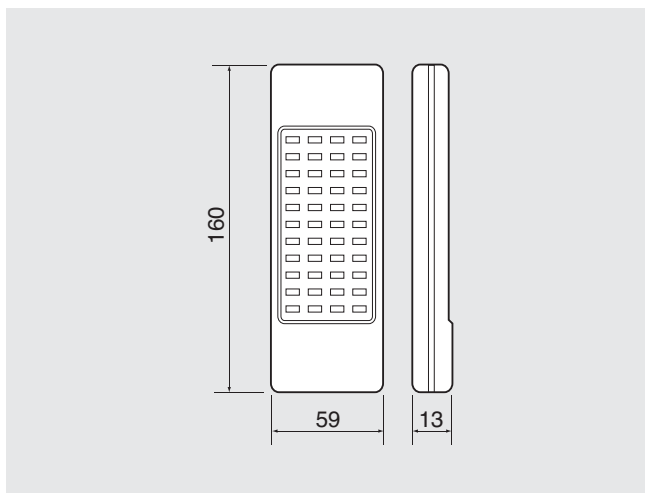

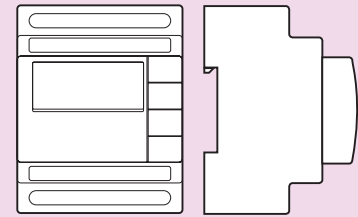
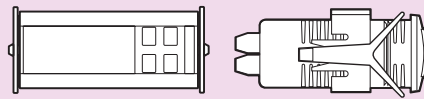

Model	IR32V*	IR32W*	IR32Z*	IRDRV*	IRDRW*	IRDRZ*
Power supply						
– 12 to 24 Vac/dc (type E + L) ±10% 50/60 Hz	•					•
– 110 to 230 Vac/dc (type H) ±10% 50/60 Hz	•					
– 24 Vac ±10% 50/60 Hz		•	•	•	•	
– 230 Vac ±15% 50/60 Hz				•	•	
Dimensions	75x33x64 mm			4 DIN module		
Mounting	panel mounting			DIN-rail mounting		
Fitting	screw terminal block for cables from 0.5 to 1.5 mm <sup>2</sup>					
Operating conditions	0T50 °C, <90% rH					
Storage conditions	-10T70 °C, <90% rH					
Output number	1	2	4	1	2	4
Output	250 Vac / 8 A res.					
Input	0 to 20 mA or 4 to 20 mA (IR32*3* or IRDR*3*) – -0.5 to 1 Vdc (IR32*4* or IRDR*4*)					
Display	3 digits with decimal point and sign ±					
Precision	±1% of full scale					
Programming	from keypad, remote control and serial card					
Optional communication components	IR32SER or IRDRSER for unit supervision and remote control					
Index of protection	IP40			IP65		





**Headquarters:**

**CAREL S.p.A.**

Via dell'Industria, 11 - 35020 Brugine - Padova (Italy)  
Tel. (+39) 0499 716611 - Fax (+39) 0499 716600  
e-mail: carel@carel.it - www.carel.it

**Subsidiaries:**

**CAREL Australia Pty Ltd**

www.carel.com.au  
e-mail: sales@carel.com.au

**CAREL China Ltd.**

www.carelhk.com  
e-mail: sales@carelhk.com

**CAREL Deutschland GmbH**

www.carel.de  
e-mail: info@carel.de

**CAREL France Sarl**

www.carelfrence.fr  
e-mail: carelfrence@carelfrence.fr

**CAREL Sud America Ltda.**

www.carel.com.br  
e-mail: carelsudamerica@carel.com.br

**CAREL U.K. Ltd.**

www.careluk.co.uk  
e-mail: careluk@careluk.co.uk

**CAREL USA L.L.C.**

www.carelusa.com  
e-mail: sales@carelusa.com

[www.carel.com](http://www.carel.com)

